

UV-verklebbare Beschläge

UV-glueable fittings

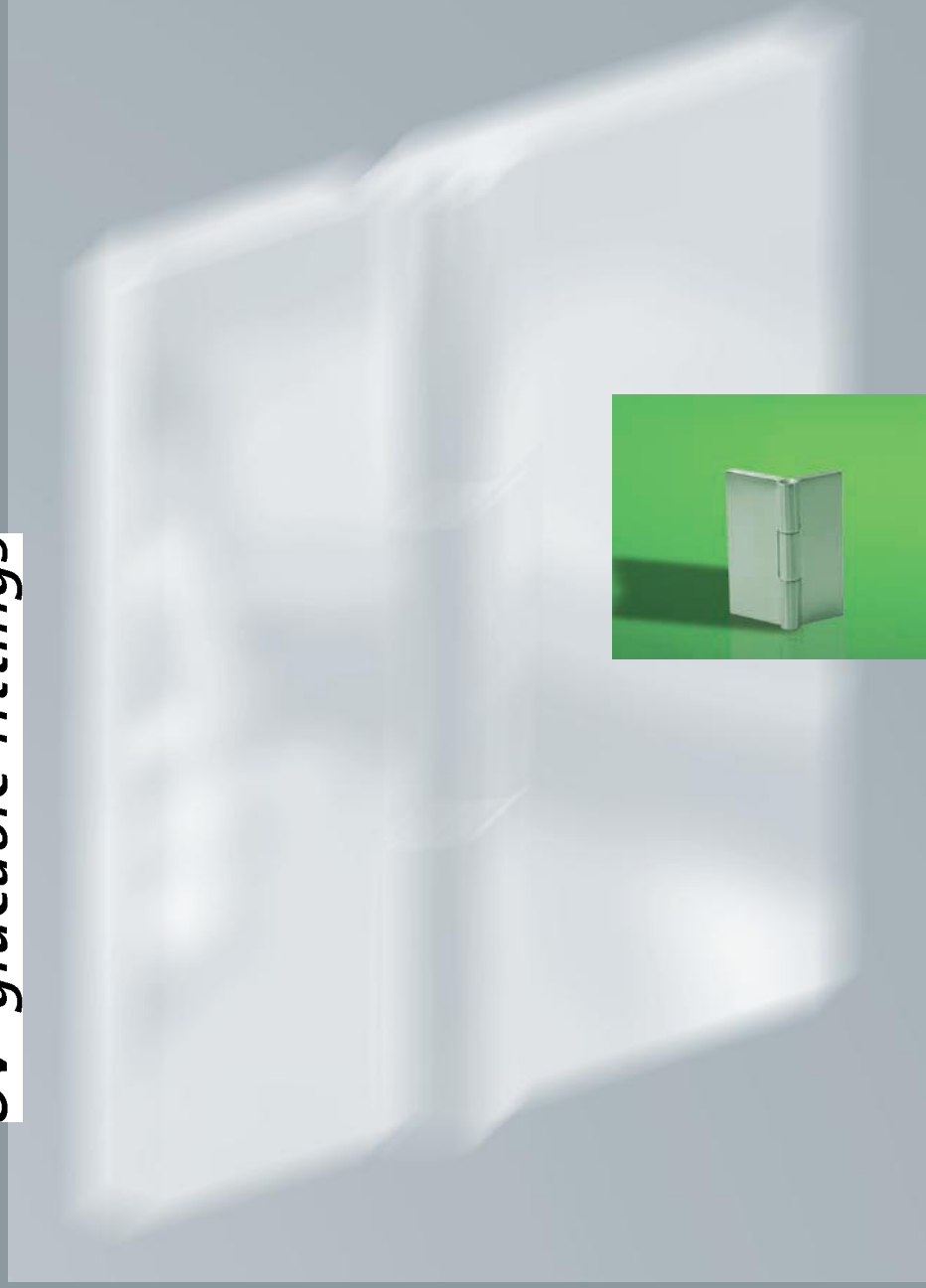

Inhalt/contents

- UV-verklebbare Scharniere/
UV-glueable glass door hinges 379
- Glastürschlösser/
glass door locks 391
- Glasbodenträger/
glass shelf support 394
- Glastürknöpfe/
glass door knobs 395
- Füße + Rollen/
furniture legs + wheels 396
- Zubehör/
extras 399
- Montage Informationen/
assembly instructions 401
- Farben/
colours 406

UV-verklebbare Beschläge

UV-glueable fittings



Transparenz durch UV-verklebbare Scharniere

Dank ihrer Leichtigkeit und Transparenz gewinnen Glas und Stahl bei der Gestaltung von Wohnbereichen immer mehr „Fans“.

Jetzt eröffnen unsere UV-verklebbaren Scharniere ganz neue Verwendungsmöglichkeiten. Auf Schrauben und Bohrungen kann komplett verzichtet werden. Darüber hinaus begeistern die Scharniere durch ihre filigrane Optik und ein harmonisches Design.

Transparency thanks to UV-glueable hinges

Due to their lightness and transparency in the design of living areas, more and more people are becoming fans of glass and steel.

Our UV-glueable hinges are opening up completely new possibilities. There is no need for screws or drilling plus these hinges have a beautifully subtle design that blends in very well.

07

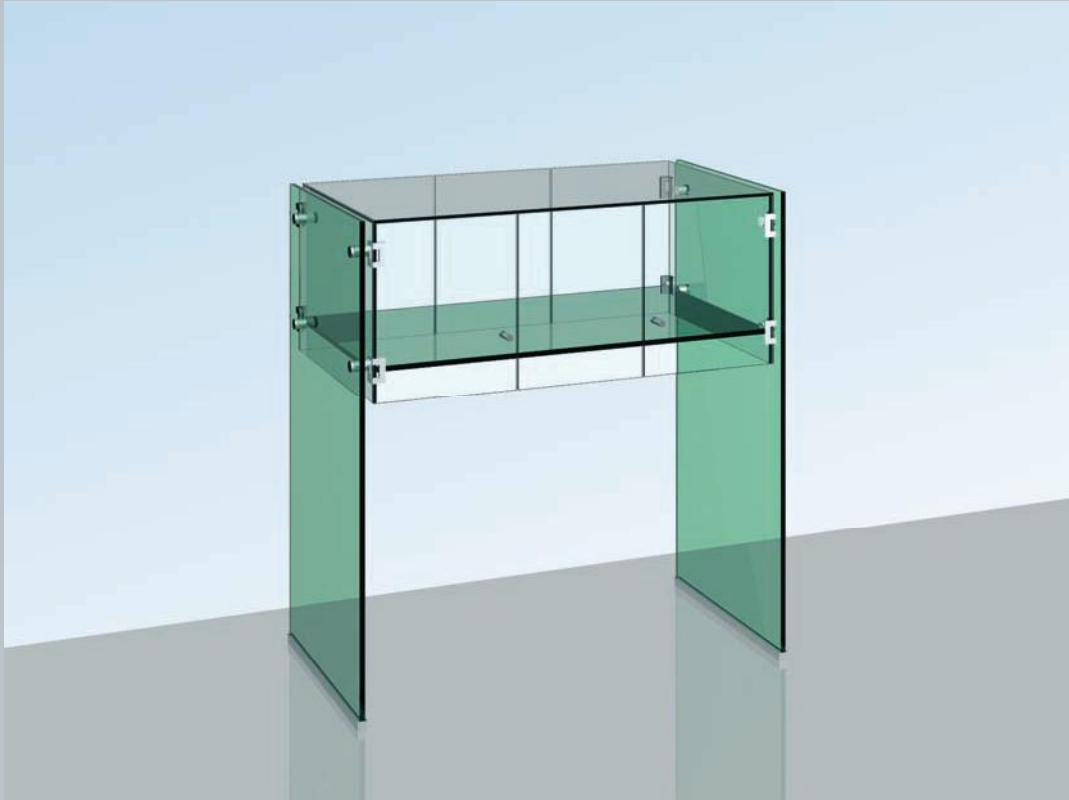



07

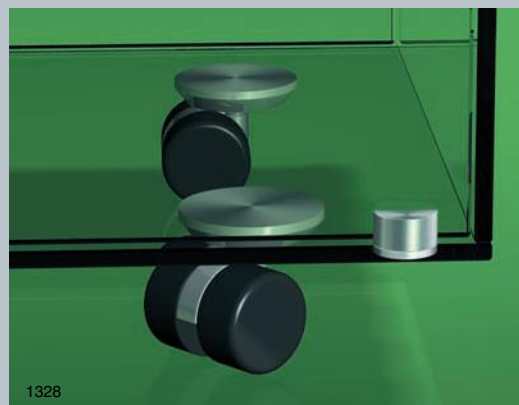
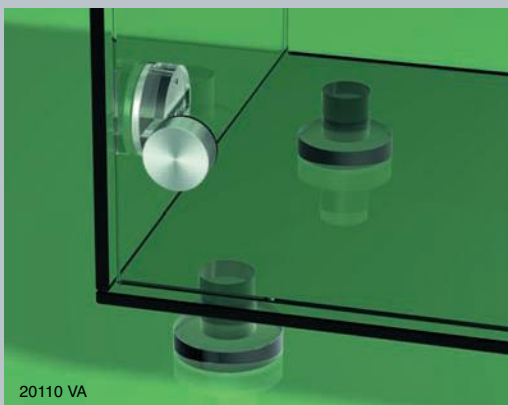

UV-Scharniere-Einzelteile

UV-glass door hinges-individual parts



UV-Scharniere-Einzelteile

UV-glass door hinges-individual parts

UV-verklebbare Beschläge/UV-glueable glass door hinges

Glastürschlösser/glass door locks

Glasbodenträger/glass shelf support

Glastürknöpfe/glass door knobs

Füße + Rollen/leg bases and casters

Zubehör/extras

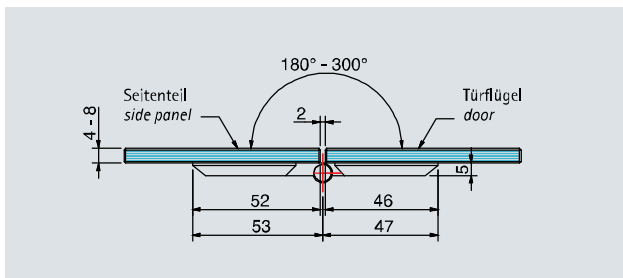
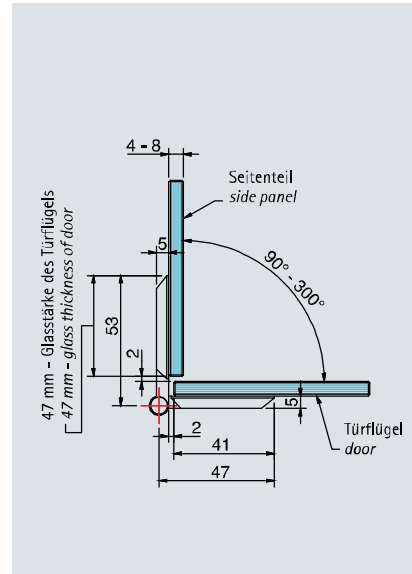
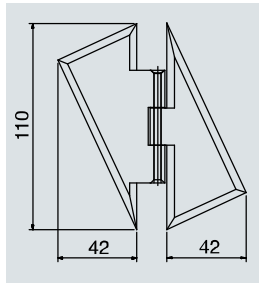

07

Artikel-Nr. article-no.	Oberflächen finishes	Artikelbezeichnung article name	Merkmale features	Plattendicke plate thickness	Zubehör extras	VE/Stück pu/piece
20000	VA1 VA2	UV-verklebbares Glastürscharnier für Ganzglaskonstruktionen/ UV-glueable glass door hinge for complete glass constructions	Max. Belastbarkeit 14 kg/Paar/ max. loadability 14 kg/pair,	4 - 8 mm	20300	1/1

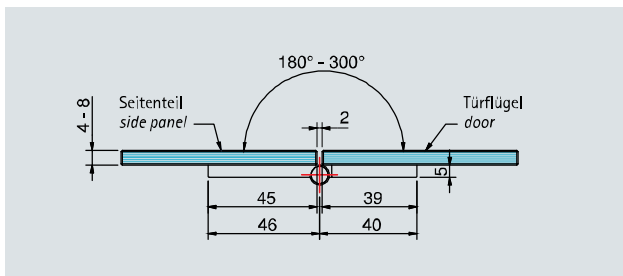
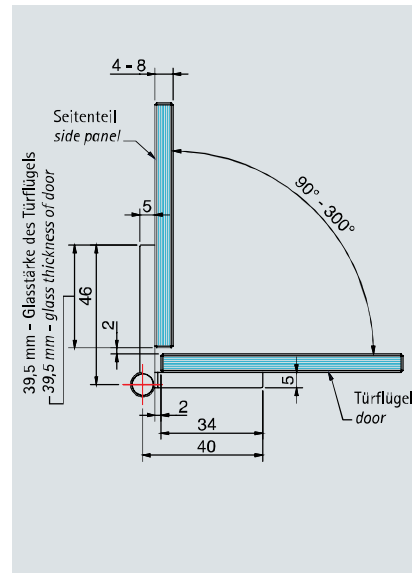
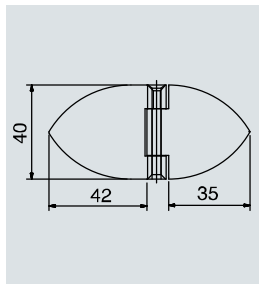

Artikel-Nr. article-no.	Oberflächen finishes	Artikelbezeichnung article name	Merkmale features	Plattendicke plate thickness	Zubehör extras	VE/Stück pu/piece
20010	VA1 VA2	UV-verklebbares Glastürscharnier für Ganzglaskonstruktionen/ UV-glueable glass door hinge for complete glass constructions	Max. Belastbarkeit 14 kg/Paar, max. loadability 14 kg/pair	4 - 8 mm	20300	1/1

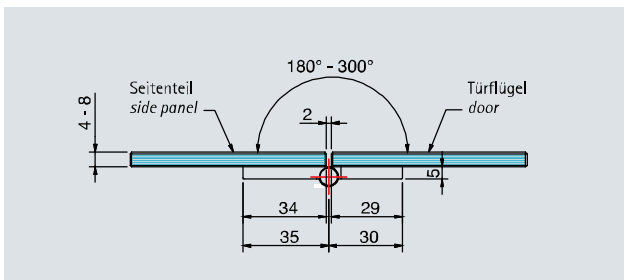
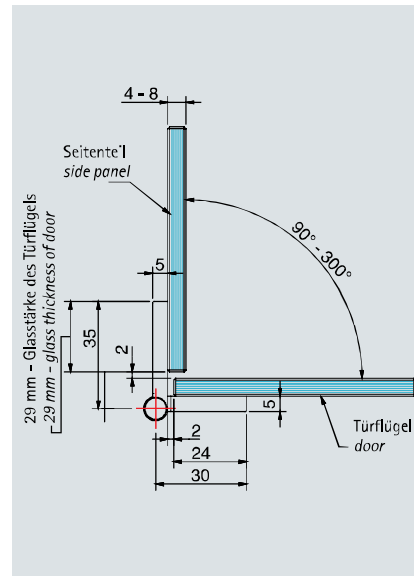
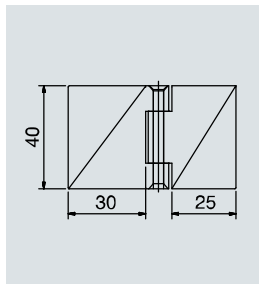

Artikel-Nr. article-no.	Oberflächen finishes	Artikelbezeichnung article name	Merkmale features	Plattendicke plate thickness	Zubehör extras	VE/Stück pu/piece
20020	VA1 VA2	UV-verklebbares Glastürscharnier für Ganzglaskonstruktionen/ UV-glueable glass door hinge for complete glass constructions	Max. Belastbarkeit 14 kg/Pair/ max. loadability 14 kg/pair	4 - 8 mm	20300	1/10

07

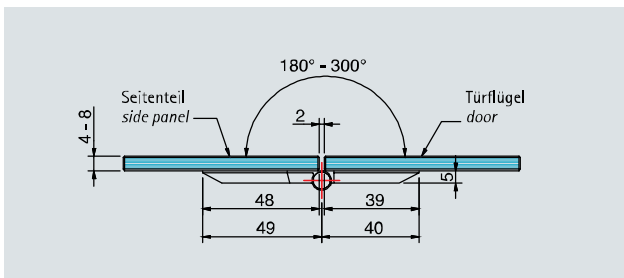
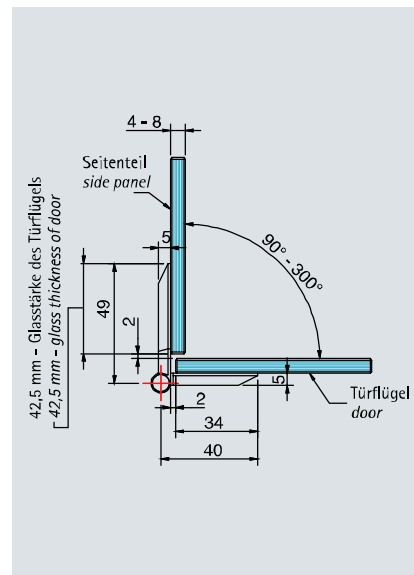
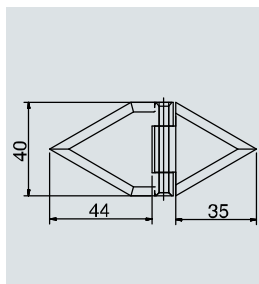

Artikel-Nr. article-no.	Oberflächen finishes	Artikelbezeichnung article name	Merkmale features	Plattendicke plate thickness	Zubehör extras	VE/Stück pu/piece
20030	VA1 VA2	UV-verklebbares Glastürscharnier für Ganzglaskonstruktionen/ UV-glueable glass door hinge for complete glass constructions	Max. Belastbarkeit 14 kg/Pair/ max. loadability 14 kg/pair	4 - 8 mm	20300	1/10

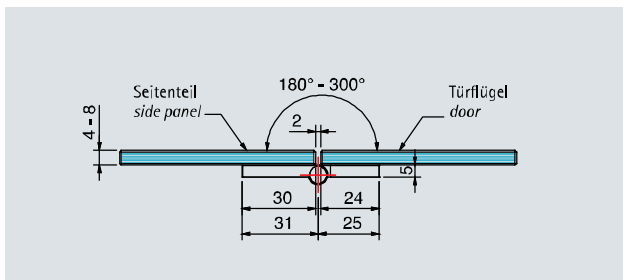
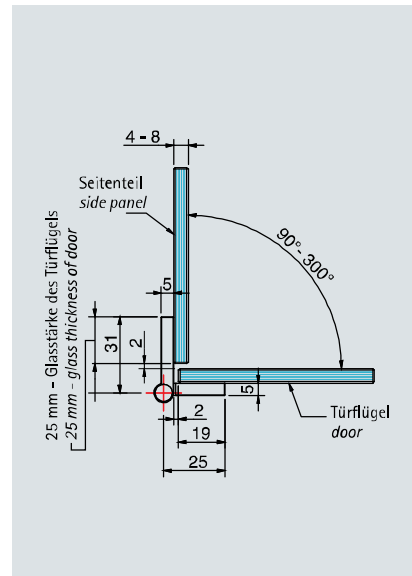
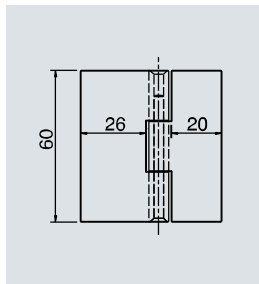

07

Artikel-Nr. article-no.	Oberflächen finishes	Artikelbezeichnung article name	Merkmale features	Plattendicke plate thickness	Zubehör extras	VE/Stück pu/piece
20040	VA1 VA2	UV-verklebbares Glastürscharnier für Ganzglaskonstruktionen/ UV-glueable glass door hinge for complete glass constructions	Max. Belastbarkeit 14 kg/Pair/ max. loadability 14 kg/pair	4 - 8 mm	20300	1/10

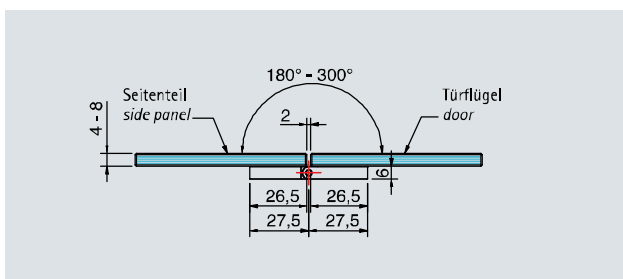
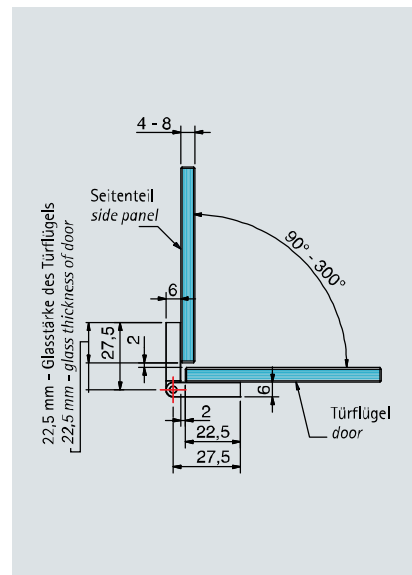
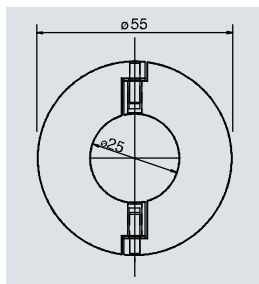

Artikel-Nr. article-no.	Oberflächen finishes	Artikelbezeichnung article name	Merkmale features	Plattendicke plate thickness	Zubehör extras	VE/Stück pu/piece
20061	VA2	UV-verklebbares Glastürscharnier 90°-300°/ UV-glueable glass door hinge 90°-300°	Rechts und links verwendbar, Max. Belastbarkeit 14 kg/Pair/ usable right and left, max. loadability 14 kg/pair	4 - 8 mm	20300	1/10

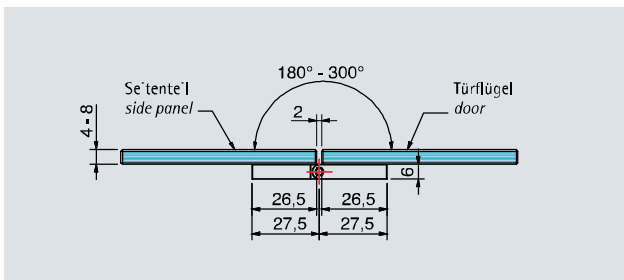
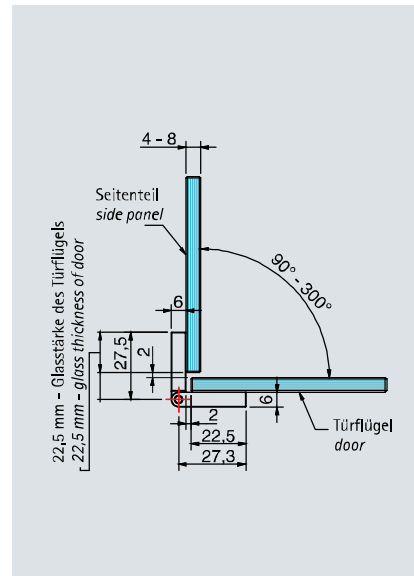
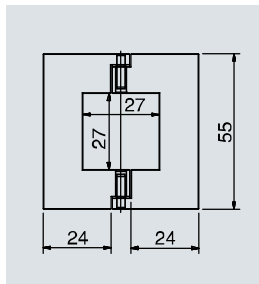

Artikel-Nr. article-no.	Oberflächen finishes	Artikelbezeichnung article name	Merkmale features	Plattendicke plate thickness	Zubehör extras	VE/Stück pu/piece
20062	VA2	UV-verklebbares Glastürscharnier 90°-300°/ UV-glueable glass door hinge 90°-300°	Rechts und links verwendbar, Max. Belastbarkeit 14 kg/Pair/ usable right and left, max. loadability 14 kg/pair	4 - 8 mm	20300	1/10

07

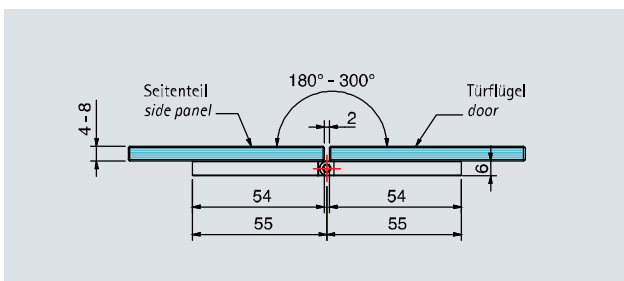
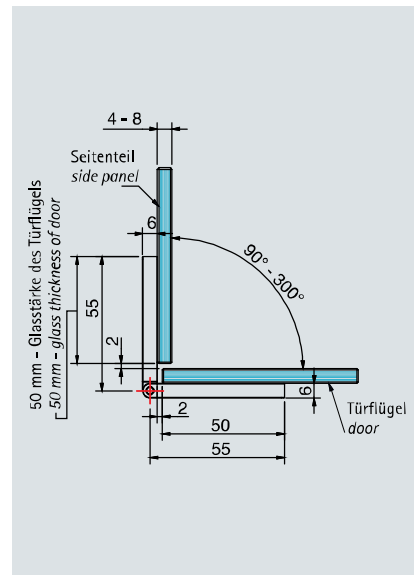
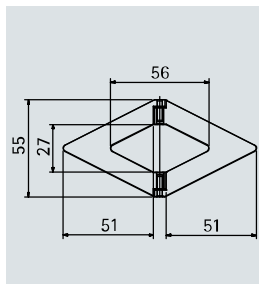

Artikel-Nr. article-no.	Oberflächen finishes	Artikelbezeichnung article name	Merkmale features	Plattendicke plate thickness	Zubehör extras	VE/Stück pu/piece
20063	VA2	UV-verklebbares Glastürscharnier 90°-300°/ UV-glueable glass door hinge 90°-300°	Rechts und links verwendbar, Max. Belastbarkeit 14 kg/Pair/ usable right and left, max. loadability 14 kg/pair	4 - 8 mm	20300	1/10

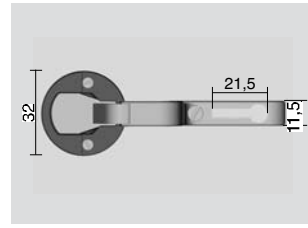
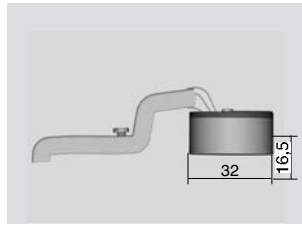

Artikel-Nr. article-no.	Oberflächen finishes	Artikelbezeichnung article name	Merkmale features	Plattendicke plate thickness	Zubehör extras	VE/Stück pu/piece
20100	VA	UV-verklebbares einliegendes Glastürscharnier 90° inkl. Kreuzmontageplatte mit Schnäpperfunktion <i>UV-glueable enclosed glass door hinge 90° incl. cross mounting plate with spring bolt action</i>	Rechts und links verwendbar, 8 kg Belastung pro Paar/ <i>usable right and left, load up to 8 kg per pair</i>	6 - 8 mm	20300 20220	1/10

07

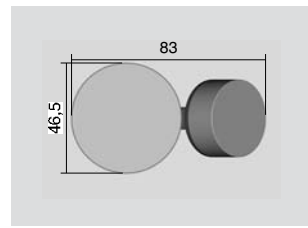
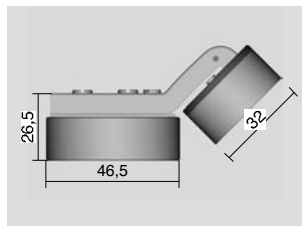

Artikel-Nr. article-no.	Oberflächen finishes	Artikelbezeichnung article name	Merkmale features	Plattendicke plate thickness	Zubehör extras	VE/Stück pu/piece
20105	VA	UV-verklebbares Glastürscharnier 135° für einliegende Türen mit Schnäpperfunktion <i>UV-glueable glass door hinge 135° for flush mounted doors with spring bolt action</i>	Rechts und links verwendbar, 8 kg Belastung pro Paar/ <i>usable right and left, load up to 8 kg per pair</i>	6 - 8 mm	20300 20220	1/10

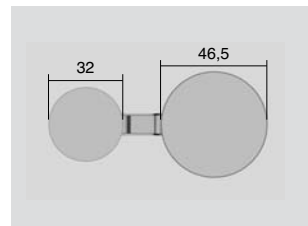
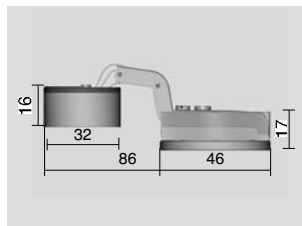

Artikel-Nr. article-no.	Oberflächen finishes	Artikelbezeichnung article name	Merkmale features	Plattendicke plate thickness	Zubehör extras	VE/Stück pu/piece
20110	VA	UV-verklebbares Glastürscharnier 90° für einliegende Türen mit Schnäpperfunktion <i>UV-glueable glass door hinge 90° for flush mounted doors with spring bolt action</i>	Rechts und links verwendbar, 8 kg Belastung pro Paar/ <i>usable right and left, load up to 8 kg per pair</i>	6 - 8 mm	20300 20220	1/10

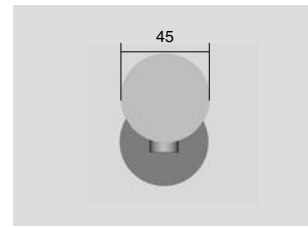
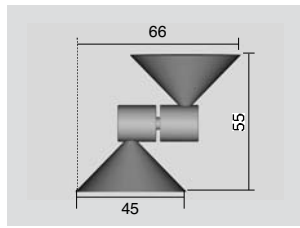

Artikel-Nr. article-no.	Oberflächen finishes	Artikelbezeichnung article name	Merkmale features	Plattendicke plate thickness	Zubehör extras	VE/Stück pu/piece
20115	VA	UV-verklebbares Glastürscharnier 180° für aufliegende Türen/ UV-glueable glass door hinge 90° for surface mounted doors	Rechts und links verwendbar, 30 kg Belastung pro Paar/ usable right and left, load up to 30 kg per pair	6 - 15 mm	20300	1/10

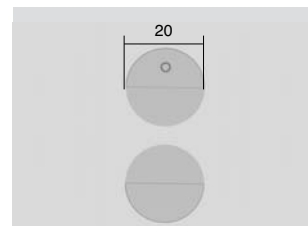
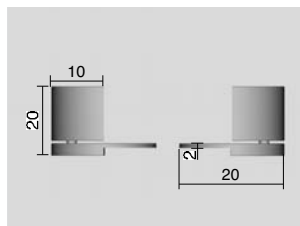
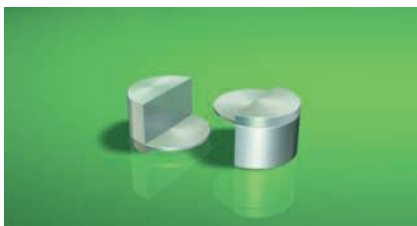

Artikel-Nr. article-no.	Oberflächen finishes	Artikelbezeichnung article name	Merkmale features	Plattendicke plate thickness	Zubehör extras	VE/Stück pu/piece
20120	VA	UV-verklebbares Glastürscharnier für einliegende Türen bis/ UV-glueable glass door hinge for flush mounted doors	Rechts und links verwendbar 20 kg Belastung pro paar/ usable right and left load up to 20 kg per pair	12 mm	20300	1/20 (10 Paar/ 10 pair)

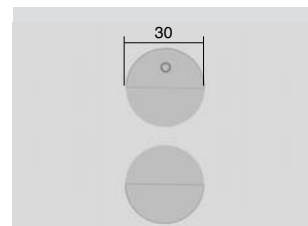
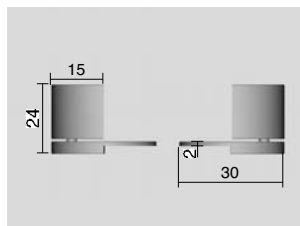
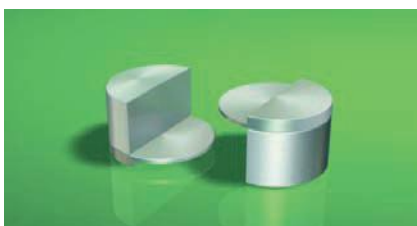

Artikel-Nr. article-no.	Oberflächen finishes	Artikelbezeichnung article name	Merkmale features	Plattendicke plate thickness	Zubehör extras	VE/Stück pu/piece
20125	VA	UV-verklebbares Glastürscharnier für einliegende Türen bis/ UV-glueable glass door hinge for flush mounted doors	Rechts und links verwendbar 20 kg Belastung pro paar/ usable right and left load up to 20 kg per pair	12 mm	20300	1/20 (10 Paar/ 10 pair)

07

Die zugehörigen Klebemaße finden Sie in unseren Montageanleitungen./You will find the associated adhesive in the assembly instructions.

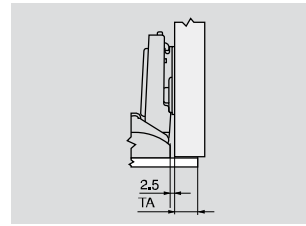
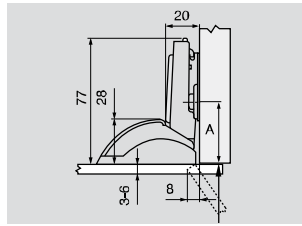

Artikel-Nr. article-no.	Oberflächen finishes	Artikelbezeichnung article name	Merkmale features	Plattendicke plate thickness	Zubehör extras	VE/Stück pu/piece
20140	ZN4	UV-verklebbares Glastürscharnier und aufliegende Türen/ UV-glueable glass door hinge for flush surface mounted doors	mit Schnäpperfunktion 6 kg Belastung pro paar/ with spring bolt action load up to 6 kg per pair	-	20300 20145	1/10
20141			ohne Schnäpperfunktion 6 kg Belastung pro paar/ without spring bolt action load up to 6 kg per pair			

07

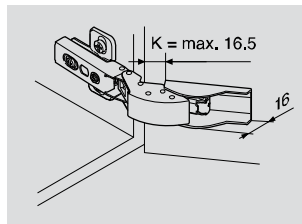

Artikel-Nr. article-no.	Oberflächen finishes	Artikelbezeichnung article name	Merkmale features	Zubehör accessories	Bohrung boring	VE/Stück pu/piece
20145	ST2	Kreuzmontageplatte/ clip cross mounting plate	Höhenverstellung, Langlöcher und vormontierte Direktbefestigungsschrauben/ height adjustment, oblong holes and pre-assembled direct clamp bolts	20140, 20141	ø 5 x 12 mm Lochabstand 32 mm/ ø 5 x 12 mm boring pitch 32 mm	1/20

Planungsmaße / Installation dimensions

Scharniermaße bei Werkseinstellung (Montageplatte Distanz = 0 mm)/
Hinge dimensions and gap on factory setting (mounting plate spacing=0 mm)
Türsprung bei vollem Öffnungswinkel / Hinge and door protrusion at full opening angle

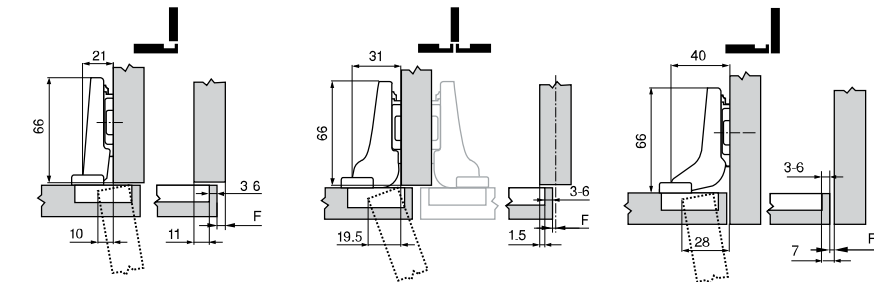

F Fuge/ Gap

Anschraubposition der Montageplatte um die Türstärke + 1 mm zurücksetzen /
Set mounting plate back by door thickness + 1 mm

TA	5 6 7 8 9 10 11 12 13 14 15 16 17	TA	-4° -3° -2° -1° 0° 1° 2° 3° 4° 5° 6° 7°	TA	-4 -3 -2 -1
TB	3 4 5 6 0	TB	3 4 5 6 0	TB	3 4 5 6 0
	3 4 5 6 3		3 4 5 6 3		3 4 5 6 0
	3 4 5 6 6		3 4 5 6 6		
	3 4 5 6 9		3 4 5 6 9		
	MD		MD		MD

TA Türschwelle / Door thickness
TB Topabstand / Drilling distance
MD Montageplatte Distanz / A trial application is recommended

Die zugehörigen Klebemaße finden Sie in unseren Montageanleitungen./You will find the associated adhesive in the assembly instructions.

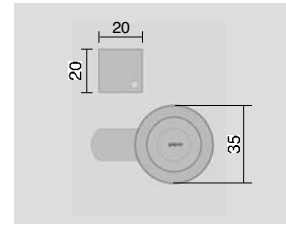
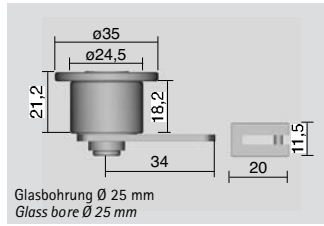

Artikel-Nr. article-no.	Oberflächen finishes	Artikelbezeichnung article name	Merkmale features	Plattendicke plate thickness	Glasbohrung glass bore	VE/Stück pu/piece
20150	VA	Glastürschloß mit Schließzylinder / glass door lock with locking cylinder	2 Schlüssel, gleichschließend / 2 keys, same locking action	6 - 15 mm	Ø 25 mm	1/5

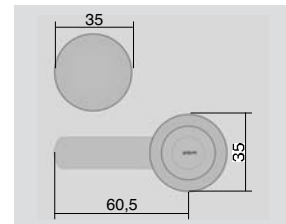
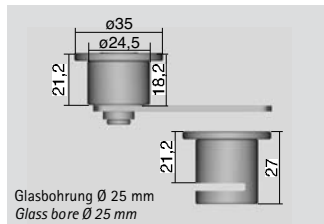

Artikel-Nr. article-no.	Oberflächen finishes	Artikelbezeichnung article name	Merkmale features	Plattendicke plate thickness	Glasbohrung glass bore	VE/Stück pu/piece
20155	VA	Glastürschloß mit Schließzylinder / glass door lock with locking cylinder	2 Schlüssel, gleichschließend für zwei-flügelige Türen / 2 keys, same locking action for double door	6 - 15 mm	Ø 25 mm	1/5

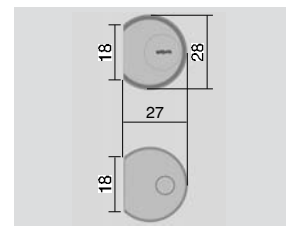
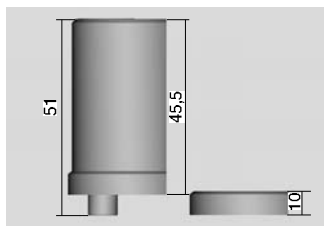

Artikel-Nr. article-no.	Oberflächen finishes	Artikelbezeichnung article name	Merkmale features	Plattendicke plate thickness	Glasbohrung glass bore	VE/Stück pu/piece
20160	VA	Glastürschloß mit Schließzylinder / glass door lock with locking cylinder	2 Schlüssel, gleichschließend, für zwei-flügelige Türen / 2 keys, same locking action, for double door	-	-	1/5

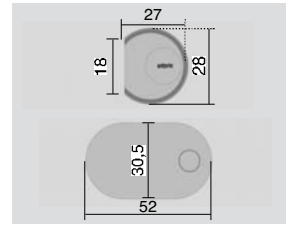
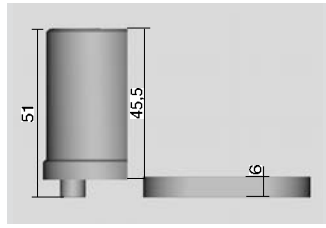

Artikel-Nr. article-no.	Oberflächen finishes	Artikelbezeichnung article name	Merkmale features	Plattendicke plate thickness	Glasbohrung glass bore	VE/Stück pu/piece
20165	VA	Glastürschloß mit Schließzylinder/ with locking cylinder glass door lock	2 Schlüssel, gleichschließend, für einliegende Türen/ 2 keys, same locking action, for flushmounted doors	5 - 12 mm	-	1/5

07

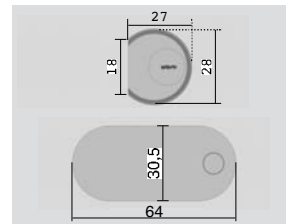
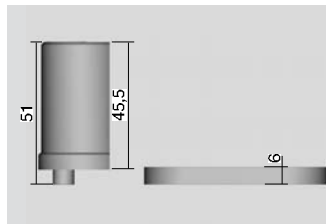

Artikel-Nr. article-no.	Oberflächen finishes	Artikelbezeichnung article name	Merkmale features	Plattendicke plate thickness	Glasbohrung glass bore	VE/Stück pu/piece
20170	VA	Glastürschloß mit Schließzylinder/ glass door lock with locking cylinder	2 Schlüssel, gleichschließend, für aufliegende Türen/ 2 keys, same locking action, for surface mounted doors	5 - 12 mm	-	1/5

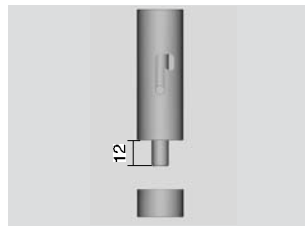
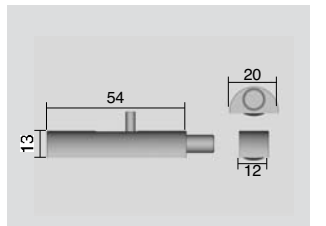

Artikel-Nr. article-no.	Oberflächen finishes	Artikelbezeichnung article name	Merkmale features	Plattendicke plate thickness	Zubehör extras	VE/Stück pu/piece
20175	VA	UV-verklebbare Türsicherung für zweiflügelige Türen/ UV-glueable bolt lock for two wing doors	-	-	20300	1/10

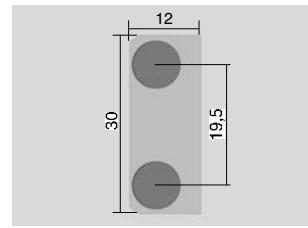
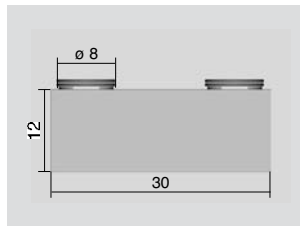

Artikel-Nr. article-no.	Oberflächen finishes	Artikelbezeichnung article name	Merkmale features	Plattendicke plate thickness	Zubehör extras	VE/Stück pu/piece
20180	VA	UV-verklebbare Magnetzuhaltung für zweiflügelige Türen/UV-glueable magnet holder for double doors	Kraft der Magnetzuhaltung 2 kg/ magnet holder for 2 kg	-	20300	1/10
20181		für einflügelige Tür/for single door				

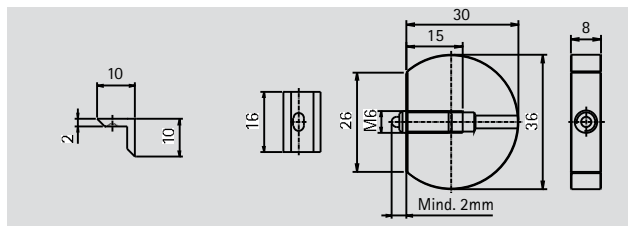
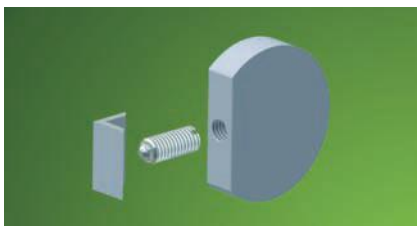

Artikel-Nr. article-no.	Oberflächen finishes	Artikelbezeichnung article name	Zubehör extras	VE/Stück pu/piece
20182	VA	UV-verklebbarer Schnapper/ UV-glueable spring bolt	20300	1/10

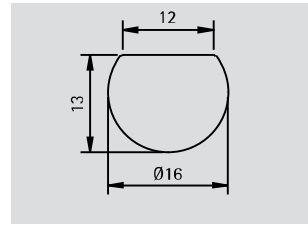
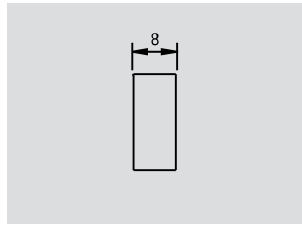
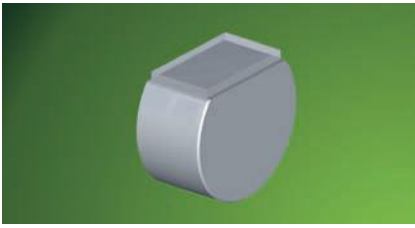

Artikel-Nr. article-no.	Oberflächen finishes	Artikelbezeichnung article name	Plattendicke plate thickness	Zubehör extras	VE/Stück pu/piece
3060	VA	UV-verklebbarer Glasbodenträger „Lastra“/ UV-glueable glass shelf support "Lastra"	-	20300	1/20

07

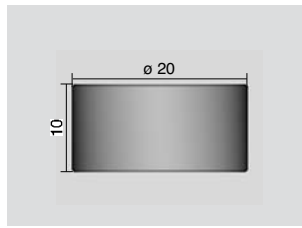
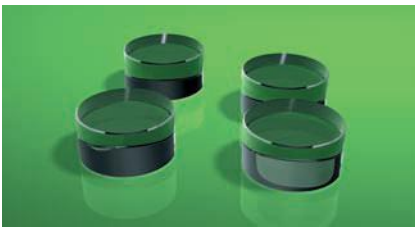

Artikel-Nr. article-no.	Oberflächen finishes	Artikelbezeichnung article name	Plattendicke plate thickness	Zubehör extras	VE/Stück pu/piece
20200	09 transparent 09 transparence	UV-verklebbare Glasronden, Borosilikatglas UV-glueable glass lenses, borosilicate glass	-	20300, 20305	1/20

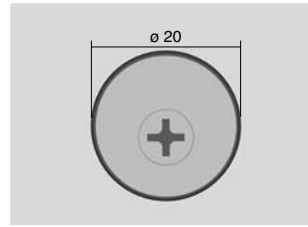
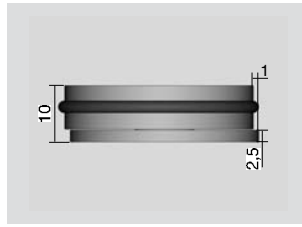
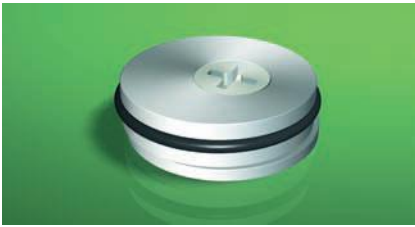

Artikel-Nr. article-no.	Oberflächen finishes	Artikelbezeichnung article name	Plattendicke plate thickness	Zubehör extras	VE/Stück pu/piece
20215	VA	UV-verklebbarer Glasbodenträger, Höhenverstellung um 1 mm/ UV-glueable glass shelf support, height adjustable 1 mm	-	20300	1/20

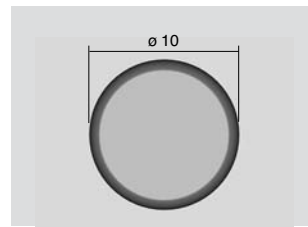
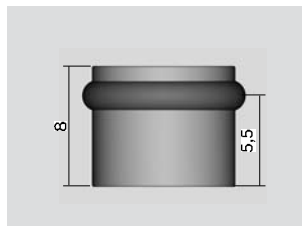

Artikel-Nr. article-no.	Oberflächen finishes	Artikelbezeichnung article name	Plattendicke plate thickness	Zubehör extras	VE/Stück pu/piece
20220	VA	UV-verklebbarer Glasbodenträger und Türstopper/ UV-glueable glass shelf support and door stop	-	20300	1/20

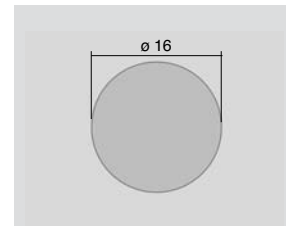
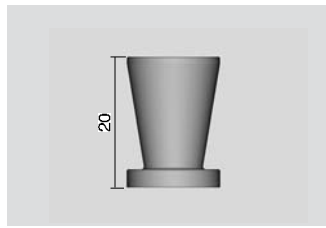

Artikel-Nr. article-no.	Oberflächen finishes	Artikelbezeichnung article name	Merkmale features	Plattendicke plate thickness	Glasbohrung glass bore	VE/Stück pu/piece
20185	VA	Glastürknopf/ glass door knob	UV-Verklebung/ UV-glueable	-	-	1/10

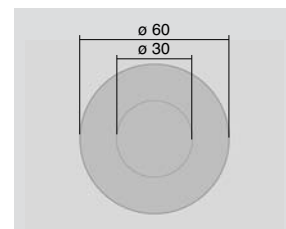
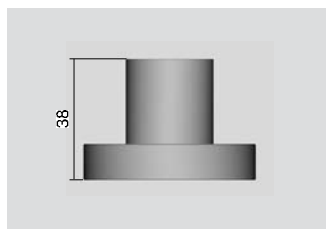

Artikel-Nr. article-no.	Oberflächen finishes	Artikelbezeichnung article name	Merkmale features	Plattendicke plate thickness	Glasbohrung glass bore	VE/Stück pu/piece
20190	09 transparent 09 transparence	Glastürknopf/ glass door knob	UV-Verklebung/ UV-glueable	-	-	1/10

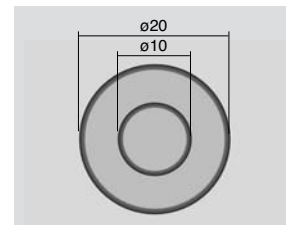
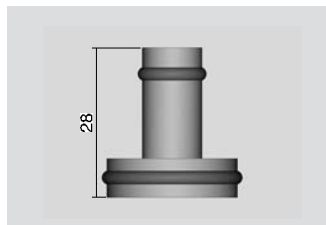

Artikel-Nr. article-no.	Oberflächen finishes	Artikelbezeichnung article name	Merkmale features	Plattendicke plate thickness	Glasbohrung glass bore	VE/Stück pu/piece
20195	VA	Glastürknopf/ glass door knob	UV-Verklebung/ UV-glueable	-	-	1/10

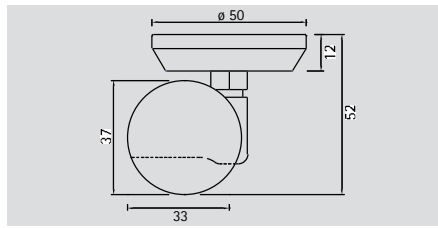

Artikel-Nr. article-no.	Oberflächen finishes	Artikelbezeichnung article name	Merkmale features	VE/Stück pu/piece
1328	-	System-Möbelrolle/ system furniture wheel	zur UV-Verklebung, ohne Feststellung, Max. Belastbarkeit 40 kg/ for UV gluing, with out locking action, maximum load capacity 40 kg	1/1

07

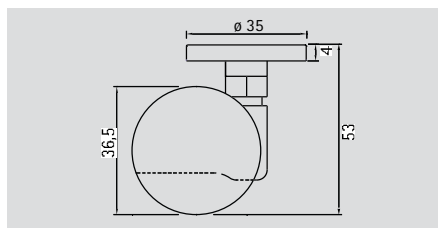

Artikel-Nr. article-no.	Oberflächen finishes	Artikelbezeichnung article name	Merkmale features	VE/Stück pu/piece
20225	-	System-Möbelrolle/ system furniture wheel	zur UV-Verklebung, mit Feststellung, Max. Belastbarkeit 25 kg/ for UV gluing, with locking action, maximum load capacity 25 kg	1/1

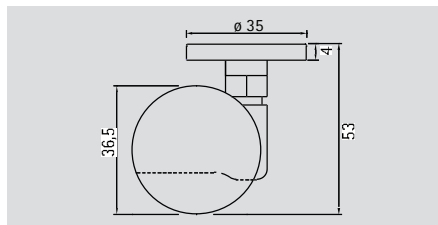

Artikel-Nr. article-no.	Oberflächen finishes	Artikelbezeichnung article name	Merkmale features	VE/Stück pu/piece
20230	-	System-Möbelrolle/ system furniture wheel	zur UV-Verklebung, ohne Feststellung, Max. Belastbarkeit 25 kg/ for UV gluing, with out locking action, maximum load capacity 25 kg	1/1



Artikel-Nr. article-no.	Oberflächen finishes	Artikelbezeichnung article name	Merkmale features	VE/Stück pu/piece
20205	VA	Möbelfuß, Abstandhalter ø 10 x 3,5 mm/ furniture caster, distance holder ø 10 x 3,5 mm	exakte Positionierung durch Verklebung, max. Belastung 15 kg/Stück/ distance holders for UV bonding, max. load approx. 15 kg/pc	1/12

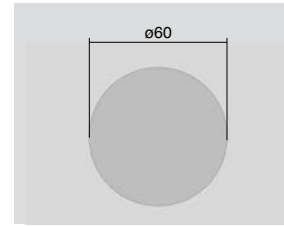
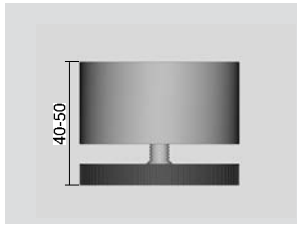

Artikel-Nr. article-no.	Oberflächen finishes	Artikelbezeichnung article name	Merkmale features	VE/Stück pu/piece
20235	VA	Möbelfuß 10 mm höhenverstellbar/ furniture leg height adjustment 10 mm	zur UV-Verklebung, verstellbar 10 mm, Max. Belastbarkeit 25 kg/ for UV gluing, adjustable 10 mm, maximum load capacity = 25 kg	1/1

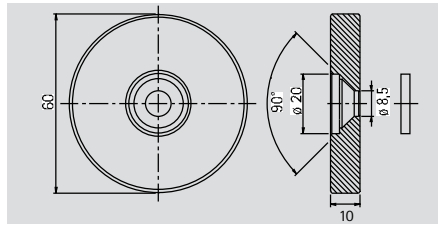
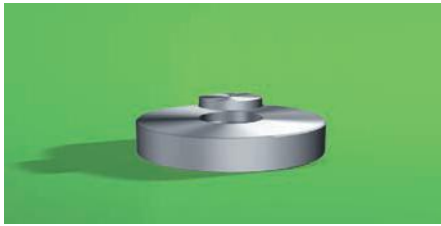

Artikel-Nr. article-no.	Oberflächen finishes	Artikelbezeichnung article name	Merkmale features	VE/Stück pu/piece
1300	VA	Platte Ø 60 mm plate Ø 60 mm	Befestigung mittels Senkkopfschraube M8. Lieferung inklusive Abdeckplatte, ø 20 mm/ mounted by means of a countersunk screw M8. The cap plate ø 20 mm is included	1/1

07

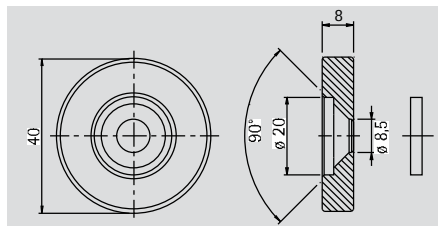

Artikel-Nr. article-no.	Oberflächen finishes	Artikelbezeichnung article name	Merkmale features	VE/Stück pu/piece
1310	VA	Platte Ø 40 mm plate Ø 40 mm	Befestigung mittels Senkkopfschraube M8. Lieferung inklusive Abdeckplatte, ø 20 mm/ mounted by means of a countersunk screw M8. The cap plate ø 20 mm is included	1/1

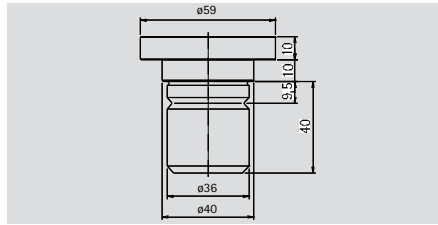

Artikel-Nr. article-no.	Oberflächen finishes	Artikelbezeichnung article name	Merkmale features	VE/Stück pu/piece
1315	VA	Zapfen mit Platte Ø 59 mm/ plug plate Ø 59 mm	zum UV verkleben/ for UV gluing	1/1