

Glasplattenträger/Glasverbinder

glass plate supports/glass connectors



Inhalt/ *contents*

- Glasplattenträger, Glasbodenträger aus Zink (ZN) und Messing (MS) 269
glass plate supports, glass shelf supports, zink (zn) and brass (ms)
- Glasplattenträger/*glass plate supports,* 270
- Glasbodenträger/*glass shelf supports* 275
- Klemmenprofile/*clamp profile* 276
- Lochschiene und Zubehör/*slotted standards and accessories* 277

- Glasplattenträger, Glasbodenträger aus Edelstahl (VA) 281
glass plate supports, glass shelf supports in stainless steel (VA)

- Glasplattenträger „Designerkollektion“ 287
glass plate supports "designer collection"

- Verbinder-Systeme 293
connector systems

- Thekenbau und Hutmuttern 301
bar building system and head screw

- Farbpalette 307
colour palette

Glasplattenträger/Glasbodenträger *Glass plate supports/Glass shelf supports*

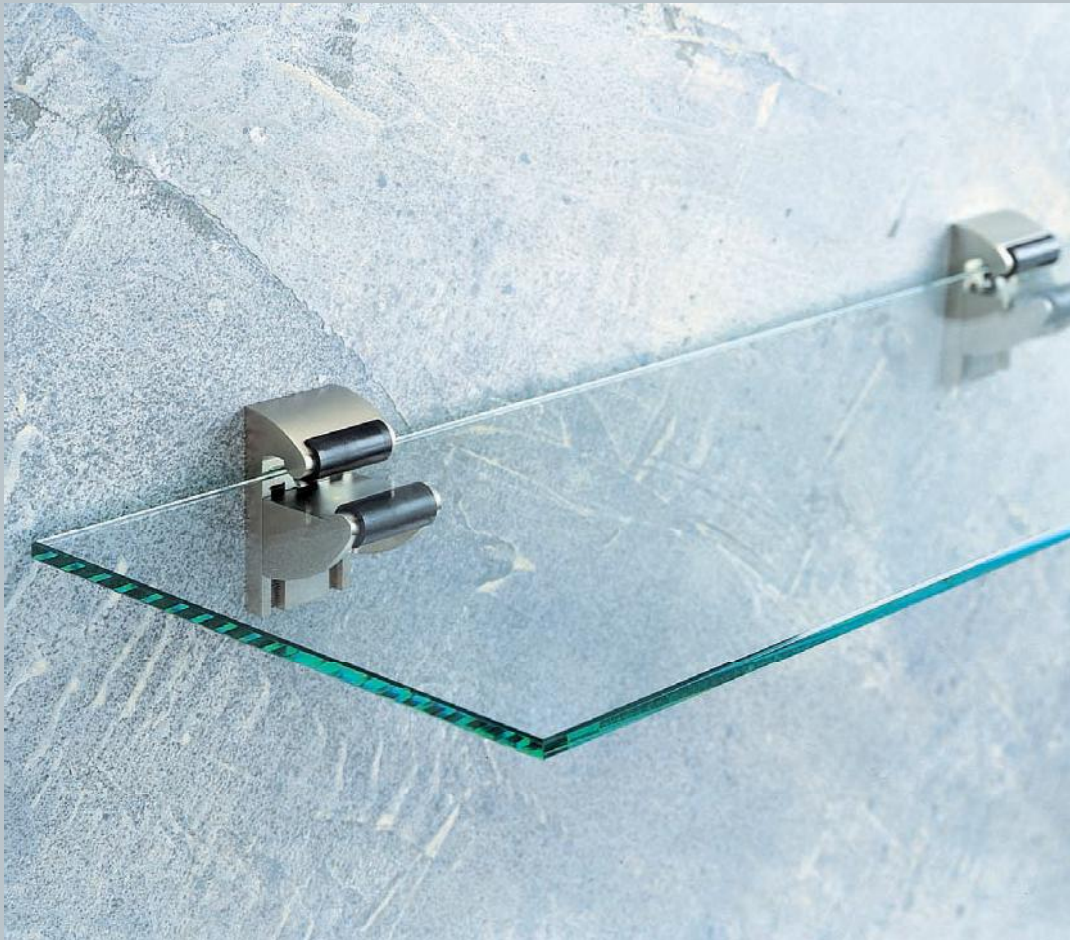

Glasplattenträger, Glasbodenträger aus Zink (ZN) und Messing (MS)
glass plate supports, glass shelf supports, zink (zn) and brass (ms)

Glasplattenträger/*glass plate supports,*

Glasbodenträger/*glass shelf supports*

Klemmenprofile/*shelf supports*

Lochschielen und Zubehör/

slotted standards and accessories

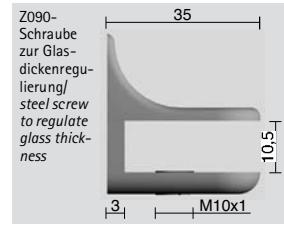
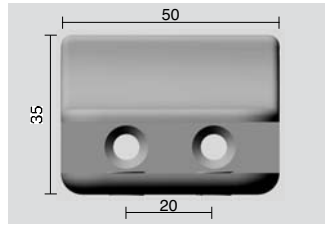

Z090-Schraube zur Glasdickenregulierung/
steel screw to regulate glass thickness

Artikel-Nr. article-no.	Oberflächen finishes	Artikelbezeichnung article name	Plattendicke plate thickness	Zubehör extras	VE/Stück pu/piece
2875	ZN0, ZN1, ZN5, ZN22 RAL-Farben/RAL colours	Glasplattenträger, 2 Befestigungsbohrungen Ø 5,5 mm für Senkkopfschrauben/glass plate support, 2 holes Ø 5,5 mm for fastening countersink head screws	8 – 10 mm	Z090-KU	1/20

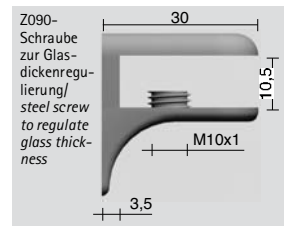
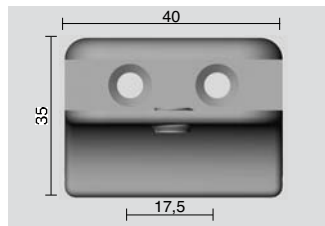

Z090-Schraube zur Glasdickenregulierung/
steel screw to regulate glass thickness

Artikel-Nr. article-no.	Oberflächen finishes	Artikelbezeichnung article name	Plattendicke plate thickness	Zubehör extras	VE/Stück pu/piece
2885	ZN0, ZN1, ZN5, ZN7, ZN22 RAL-Farben/RAL colours	Glasplattenträger, 2 Befestigungsbohrungen Ø 4,5 mm für Senkkopfschrauben/glass plate support, 2 holes Ø 4,5 mm for fastening countersink head screws	6 – 10 mm	Z090-KU	1/20

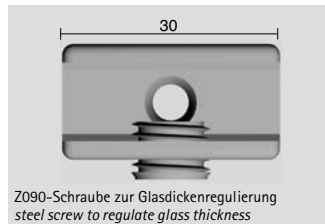

Z090-Schraube zur Glasdickenregulierung
steel screw to regulate glass thickness

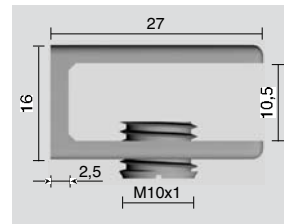

Artikel-Nr. article-no.	Oberflächen finishes	Artikelbezeichnung article name	Plattendicke plate thickness	Zubehör extras	VE/Stück pu/piece
2880	ZN0, ZN1, ZN5, ZN7 ZN22 RAL-Farben/RAL colours	Glasplattenträger, 1 Befestigungsbohrung Ø 4,5 mm für Senkkopfschraube/glass plate support, 1 hole Ø 4,5 mm for fastening countersink head screw	6 – 10 mm	Z090-KU	1/20

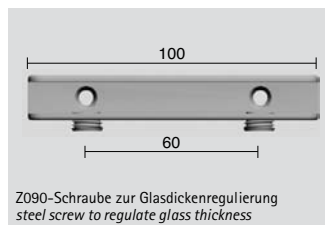

Z090-Schraube zur Glasdickenregulierung
steel screw to regulate glass thickness

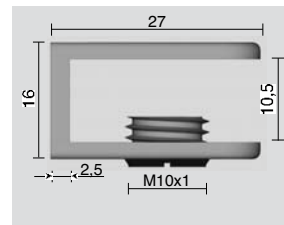

Artikel-Nr. article-no.	Oberflächen finishes	Artikelbezeichnung article name	Plattendicke plate thickness	Zubehör extras	VE/Stück pu/piece
2881	ZN0, ZN1, ZN5, ZN7 ZN22 RAL-Farben/RAL colours	Glasplattenträger, 2 Befestigungsbohrungen Ø 4,5 mm für Senkkopfschrauben/glass plate support, 2 holes Ø 4,5 mm for fastening countersink head screws	6 – 10 mm	Z090-KU	1/20

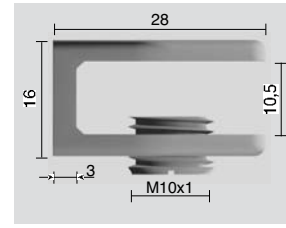
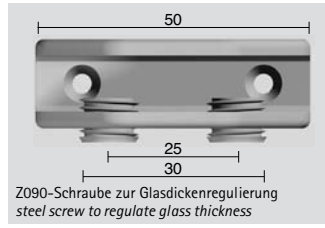
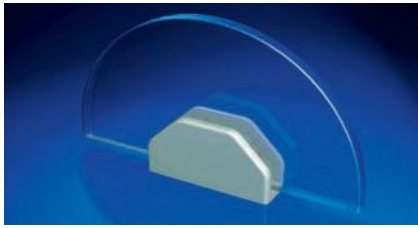

Artikel-Nr. article-no.	Oberflächen finishes	Artikelbezeichnung article name	Plattendicke plate thickness	Zubehör extras	VE/Stück pu/piece
2882	ZNO, ZN1, ZN5, ZN7 ZN22 RAL-Farben/RAL colours	Glasplattenträger, 2 Befestigungsbohrungen Ø 4,5 mm für Senkkopfschrauben/glass plate support, 2 holes Ø 4,5 mm for fastening countersink head screws	6 – 10 mm	Z090-KU	1/20

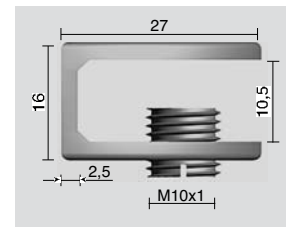
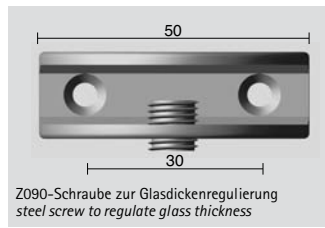

Artikel-Nr. article-no.	Oberflächen finishes	Artikelbezeichnung article name	Plattendicke plate thickness	Zubehör extras	VE/Stück pu/piece
2884	ZNO, ZN1, ZN5, ZN7 ZN22 RAL-Farben/RAL colours	Glasplattenträger, 2 Befestigungsbohrungen Ø 4,5 mm für Senkkopfschrauben/glass plate support, 2 holes Ø 4,5 mm for fastening countersink head screws	6 – 10 mm	Z090-KU	1/20

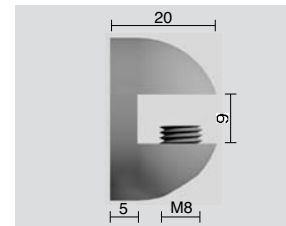
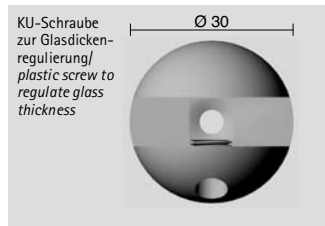
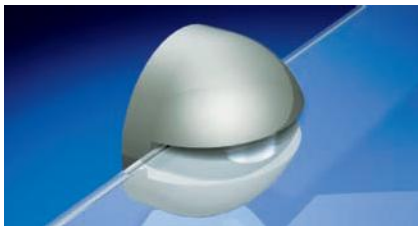

Artikel-Nr. article-no.	Oberflächen finishes	Artikelbezeichnung article name	Plattendicke plate thickness	Zubehör extras	VE/Stück pu/piece
2876	MS7, MS15	Glasplattenträger, 1 Befestigungsbohrung Ø 4,5 mm für Senkkopfschraube/glass plate support, 1 hole Ø 4,5 mm for fastening countersink head screw	6 – 8 mm	-	1/20

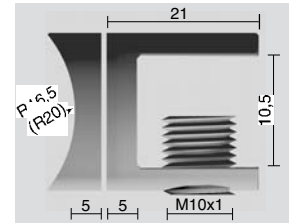
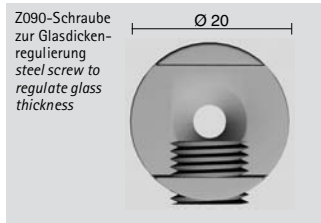

Z090-Schraube
zur Glasdicken-
regulierung
steel screw to
regulate glass
thickness

04

Artikel-Nr. article-no.	Oberflächen finishes	Artikelbezeichnung article name	Plattendicke plate thickness	Zubehör extras	VE/Stück pu/piece
2873	ZN0, ZN1, ZN5, ZN22, RAL-Farben RAL colours	Glasplattenträger mit Rundrohradapter für Ø 27-33 mm 1 Befestigungsbohrung Ø7 mm mit Senkung für M5-Senkkopfschrauben./ round tube glass plate support for Ø 27-33 mm, 1 fastening hole Ø7 mm with countersink for M5 countersink screw.	6 - 10 mm	Z090-KU	1/20

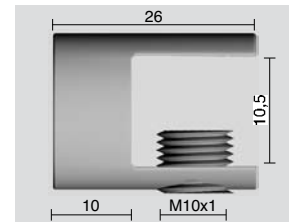
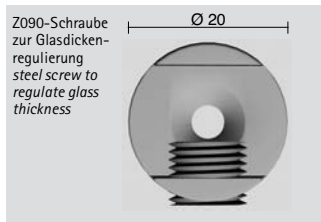

Z090-Schraube
zur Glasdicken-
regulierung
steel screw to
regulate glass
thickness

Artikel-Nr. article-no.	Oberflächen finishes	Artikelbezeichnung article name	Plattendicke plate thickness	Zubehör extras	VE/Stück pu/piece
2877	ZN0, ZN1, ZN5, ZN7, ZN22, RAL-Farben/ RAL colours	Glasplattenträger, 1 Befestigungsbohrung M6 mit Senkung für M5-Senkkopfschrauben./ glass plate support, 1 fastening hole M6 with countersink for M5 countersink screw.	6 - 10 mm	2878 ST8 2879 Z090-KU	1/20

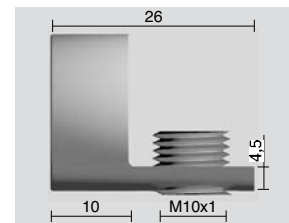
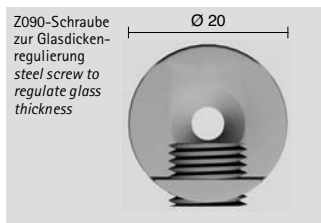
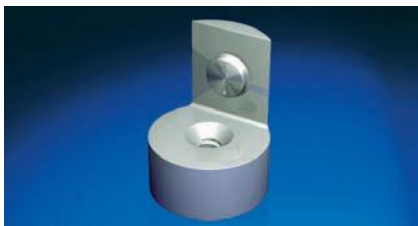

Z090-Schraube
zur Glasdicken-
regulierung
steel screw to
regulate glass
thickness

Artikel-Nr. article-no.	Oberflächen finishes	Artikelbezeichnung article name	Plattendicke plate thickness	Zubehör extras	VE/Stück pu/piece
2883	ZN0, ZN1, ZN5, ZN7, ZN22, RAL-Farben RAL colours	Glasplattenträger, 1 Befestigungsbohrung M6 mit Senkung für M5-Senkkopfschrauben./ glass plate support, 1 fastening hole M6 with countersink for M5 countersink screw.	-	2878 ST8 2879 Z090-KU	1/20

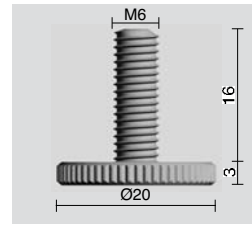
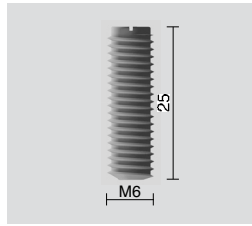

Artikel-Nr. article-no.	Oberflächen finishes	Artikelbezeichnung article name	VE/Stück pu/piece
2878	ST8	Gewindestift M6x25 mit 2 KU-Unterlegscheiben und 1 KU-Schlauchstück ø8xø6x6,5 mm / grub screw M6x25 with 2 plastic washers and 1 plastic tube ø8xø6x6,5 mm	1/20

Artikel-Nr. article-no.	Oberflächen finishes	Artikelbezeichnung article name	VE/Stück pu/piece
2879	VA0 = (ZN1) VA1 = (ZN5) VA2 = (ZN22) VA7 = (ZN7) RAL-Farben RAL colours	Rändelschraube M6x16 mit 2 KU-Unterlegscheiben und 1 KU-Schlauchstück ø8xø6x6,5 mm / knurled thumb screw M6x16 with 2 plastic washers and 1 plastic tube ø8xø6x6,5 mm	1/20

Anwendungsbeispiel zu 2877, 2883 in Verwendung mit 2878 und 2879 / example of 2877, 2883 in use with 2878 and 2879

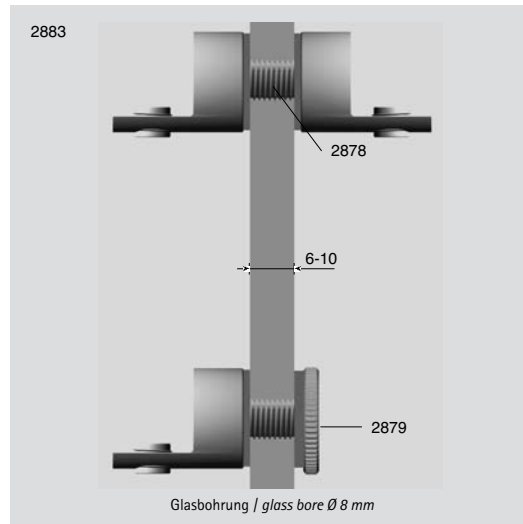
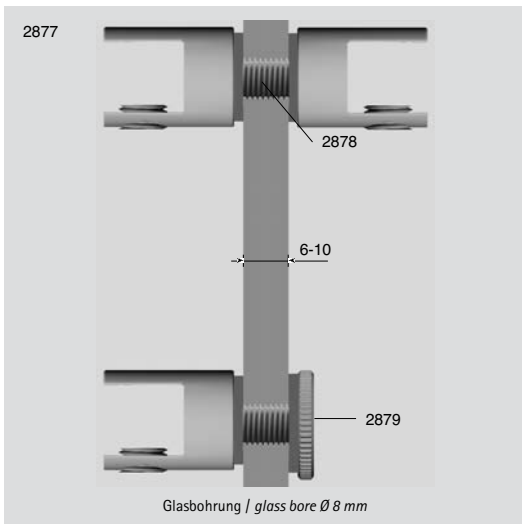



Z090-Schraube
zur Glasdicken-
regulierung/
screw to regulate
glass thickness

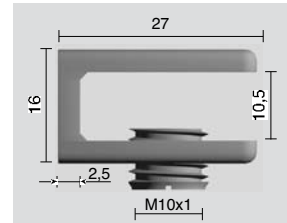

04

Artikel-Nr. article-no.	Oberflächen finishes	Artikelbezeichnung article name	Plattendicke plate thickness	Zubehör extras	VE/Stück pu/piece
2886	ZNO, ZN1, ZN5, ZN7 ZN22 RAL-Farben/RAL colours	Glasplattenträger, 1 Befestigungsbohrung \varnothing 4,5 mm für Senk- kopfschraube \varnothing 10 x 1 mm/glass plate support, 1 hole \varnothing 4,5 mm for fastening countersunk head screw \varnothing 10 x 1 mm	6 – 10 mm	Z090-KU	1/20



Z090-Schraube
zur Glasdicken-
regulierung/
screw to regulate
glass thickness

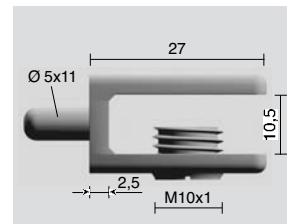
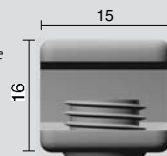

Artikel-Nr. article-no.	Oberflächen finishes	Artikelbezeichnung article name	Plattendicke plate thickness	Zubehör extras	VE/Stück pu/piece
2887	ZNO, ZN1, ZN5, ZN7 ZN22 RAL-Farben/RAL colours	Glasplattenträger mit 1 Zapfen \varnothing 5x11 mm Länge für Lochwände/ glass plate support with 1 pin \varnothing 5x11 mm length for predrilled walls	6 – 10 mm	Z090-KU	1/20



Z090-VA

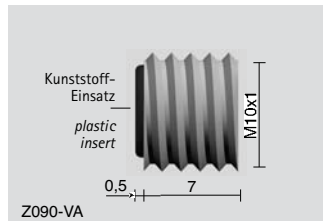

Z090-VA

Artikel-Nr. article-no.	Oberflächen finishes	Artikelbezeichnung article name	Zubehör extras	VE/Stück pu/piece
Z090	VA	Gewindestift M10x1x7 aus VA mit Kunststoffeinsatz stainless Steel grub screw M10x1x7 with a plastic insert	2875, 2877, 2880, 2881, 2882, 2883, 2884, 2885, 2886, 2887	1/20
Z090	KU	Gewindestift M10x1x8 aus Kunststoff/ plastic grub screw M10x1x8	2875, 2877, 2880, 2881, 2882, 2883, 2884, 2885, 2886, 2887	1/20

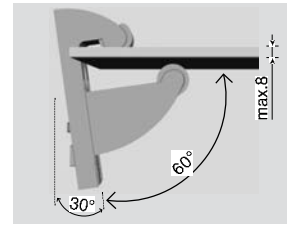
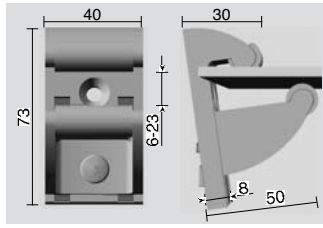
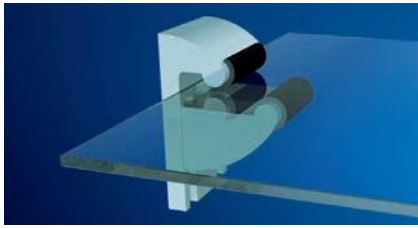

Artikel-Nr. article-no.	Oberflächen finishes	Artikelbezeichnung article name	Plattendicke plate thickness	Zubehör extras	VE/Stück pu/piece
2896	ZN0, ZN1, ZN5, ZN22, RAL-Farben/RAL colours	Universal-Bodenträger, verstellbar durch Rastereinteilung, einsetzbar in der Senkrechten sowie an Schrägen bis 30° je nach Plattendicke. 1 Befestigungsbohrung Ø 6,5 mm für Senkkopfschraube. / universal shelf support, adjustable by grooved slots, usable vertically as well as slants up to 30° depending on Plate thickness. 1 hole for fastening Ø 6,5 mm countersink head screw.	6 – 23 mm	2857 ST8	1/10

04

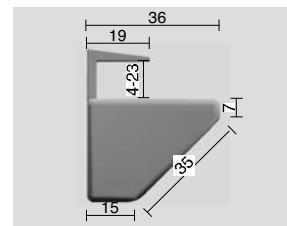
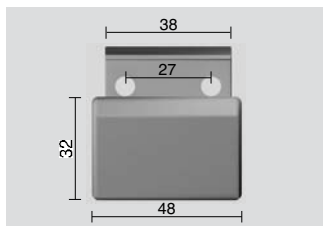
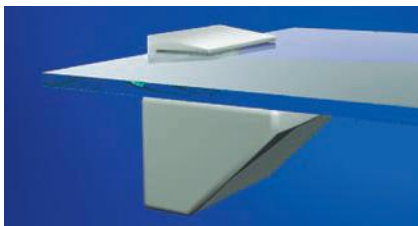

Artikel-Nr. article-no.	Oberflächen finishes	Artikelbezeichnung article name	Plattendicke plate thickness	Zubehör extras	VE/Stück pu/piece
4938	ZN0, ZN1, ZN5, ZN22, RAL-Farben/RAL colours	Regalbodenträger, stufenlos verstellbar. 2 Befestigungsbohrungen Ø 5,5 mm für Senkkopfschrauben. / shelf support, infinitely variable. 2 holes Ø 5,5 mm for fastening countersink head screws.	4 – 23 mm	-	1/10

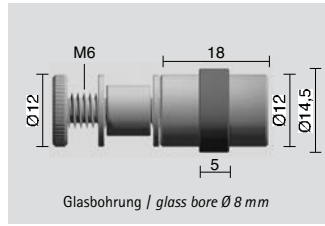
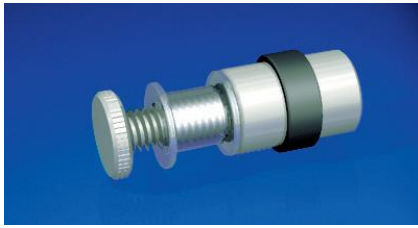

Maximale Tragfähigkeit 10 kg/
maximum load 10 kg

04

Artikel-Nr. article-no.	Oberflächen finishes	Artikelbezeichnung article name	Plattendicke plate thickness	Zubehör extras	VE/Stück pu/piece
2888	MS0, MS5	Glasbodenträger einseitig mit Gummiauflage, 1 Gewindeschraube, 2 KU-Unterlegscheiben und 1 KU-Schlauchstück./ glass shelf support, one-sided rubber support, 1 screw, 2 plastic washers and 1 plastic tube.	6 - 8 mm	Ø 8 mm	1/50

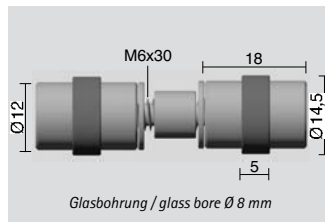

Maximale Tragfähigkeit 10 kg/
maximum load 10 kg

Artikel-Nr. article-no.	Oberflächen finishes	Artikelbezeichnung article name	Plattendicke plate thickness	Zubehör extras	VE/Stück pu/piece
2889	MS0, MS5	Glasbodenträger doppelseitig mit Gummiauflage, 1 Gewindestift, 2 KU-Unterlegscheiben und 1 KU-Schlauchstück./ glass shelf support, two-sided rubber support, 1 grub screw, 2 plastic washers and 1 plastic tube.	6 - 10 mm	Ø 8 mm	1/50

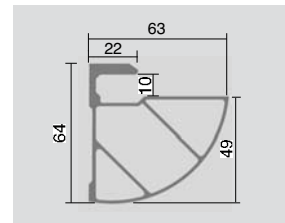
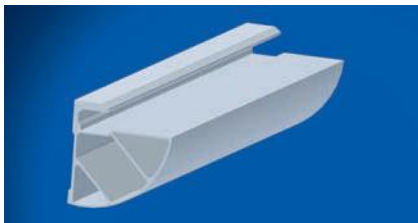

Artikel-Nr. article-no.	Oberflächen finishes	Artikelbezeichnung article name	Plattendicke plate thickness	Zubehör extras	VE/Stück pu/piece
4945	RAL-Farben RAL colours	Klemmprofil ungebohrt. Bei Befestigung ist die Wandebenheit zu prüfen! Fixlänge auf Anfrage./ clamp profile, undrilled. while mounting, control the wall flatness. Different lengths on request.	10 mm	SET-4946KU6 SET-4946KU3 4947ST8	1/5

Zubehör zu 4945 / extras for 4945

SET-4946KU6	mattverchromt matt chrome	2 Endkappen (links und rechts)/2 end caps (left and right)	-	-	1/1
SET-4946KU3 4947ST8	schwarz/ black	5 Befestigungsschrauben 4,8x60, 5 Dübel 8 mm/ 5 screws and wall plug 4,8x60, 5 dowels 8 mm	-	-	1/1



SET-4946KU3



4947ST8

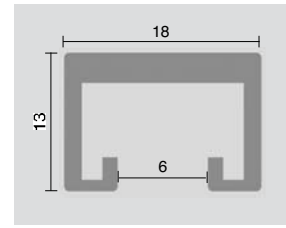
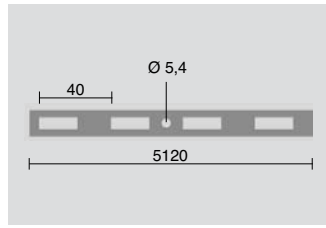

Artikel-Nr. article-no.	Oberflächen finishes	Artikelbezeichnung article name	Belegbreite bearing width	Zubehör extras	VE/Stück pu/piece
4955	E3/EV1	Lochschiene, Mehrfachböden/ slotted standard for multiple shelves	-	4956 E3/EV1, 4957 KU1, 4958, 4959 KU3	1/5,12

04

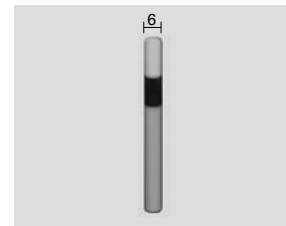
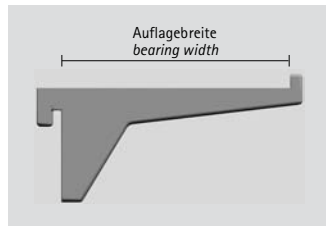

Artikel-Nr. article-no.	Oberflächen finishes	Artikelbezeichnung article name	Belegbreite bearing width	Zubehör extras	VE/Stück pu/piece
4956	E3/EV1	Lochschiementräger/ shelf support	200, 250, 300, 350 und 400 mm	4955 E3/EV1, 4957 KU1, 4958, 4959 KU3	1/10

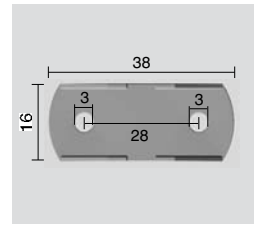
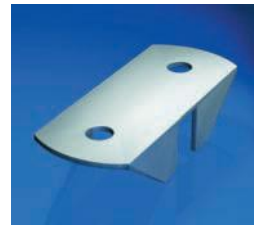
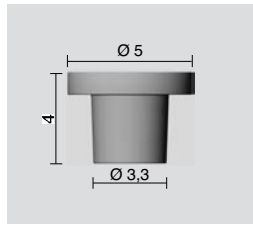

Artikel-Nr. article-no.	Oberflächen finishes	Artikelbezeichnung article name	VE/Stück pu/piece	Artikel-Nr. article-no.	Oberflächen finishes	Artikelbezeichnung article name	VE/Stück pu/piece
4957	KU1	Plastikstopfen zu Art. Nr. 4958/ plastic insert for art. no. 4958	1/100	4958	-	Querlappen (Edelstahl) zur Ab- lage/transverse, rest plate VA	1/100

04

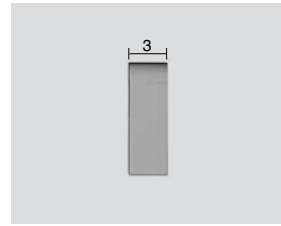
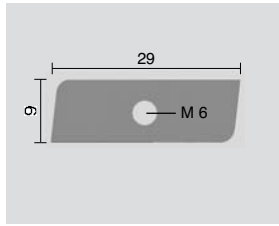

Artikel-Nr. article-no.	Oberflächen finishes	Artikelbezeichnung article name	Plattendicke plate thickness	Zubehör extras	VE/Stück pu/piece
2857	ST8	Einhängevorrichtung mit Schraube für Stahlrohre mit Rechtecklochung/hanging equipment with screw for steel tubes with rectangular punch	-	-	1/50

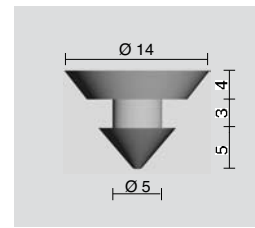
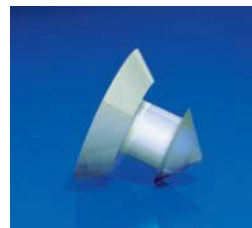
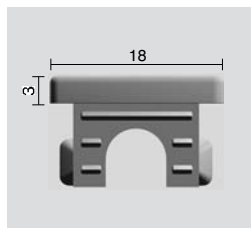

Artikel-Nr. article-no.	Oberflächen finishes	Artikelbezeichnung article name	VE/Stück pu/piece	Artikel-Nr. article-no.	Oberflächen finishes	Artikelbezeichnung article name	VE/Stück pu/piece
4959	KU3	Abschlußstopfen/ end caps	1/100	3057	KU0	Saugnapf/ suction cap	1/500

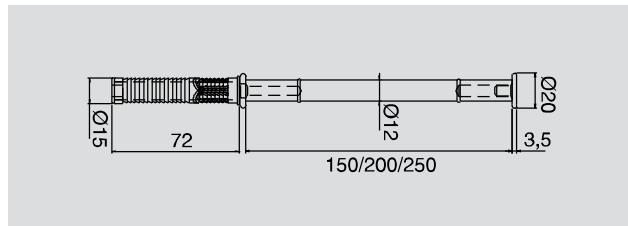
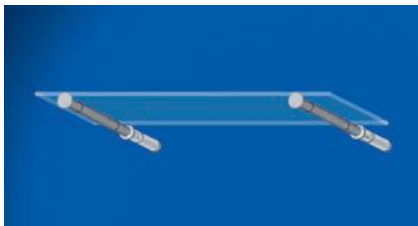

Artikel-Nr. article-no.	Oberflächen finishes	Artikelbezeichnung article name	Ausladung plate width	Zubehör extras	VE/Stück pu/piece
10050	MS7, MS10, MS18	Glasbodenträger inkl. Dübel/ glass shelf support incl. dowels	150, 200, 250 mm	10051 für überstehende Glas- scheiben/for extruding glass panes	1/2

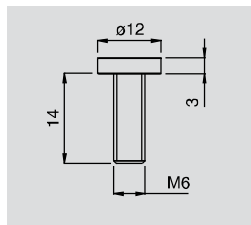

Artikel-Nr. article-no.	Oberflächen finishes	Artikelbezeichnung article name	VE/Stück pu/piece
10051	MS7, MS10 MS18	Schraube M6 für 10050/ screw M6 for 10050	1/10

Glasplattenträger/Glasbodenträger (VA) *glass plate supports/shelf supports (VA)*

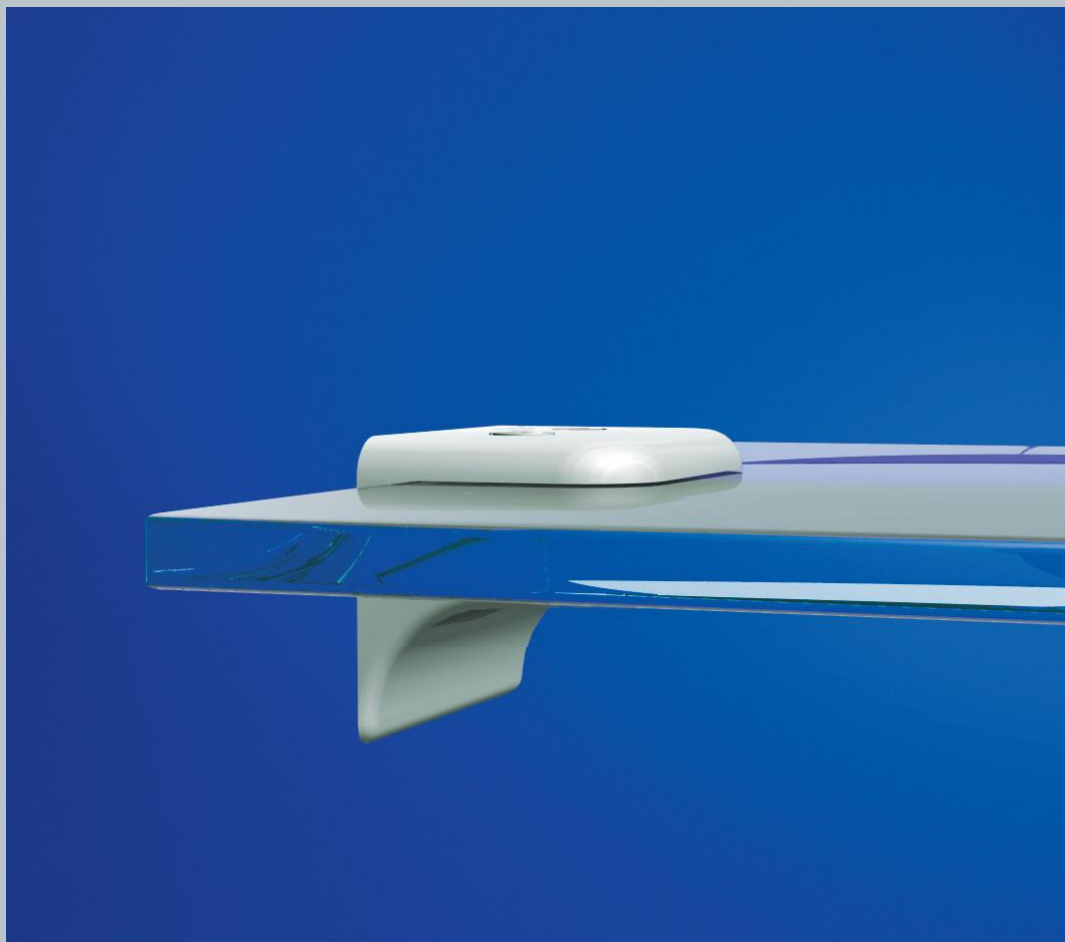

Glasplattenträger, Glasbodenträger aus VA/
glass plate supports, glass connectors, VA
Glasplattenträger/*glass plate supports,*
Glasbodenträger, Zubehör/
shelf supports, accessories

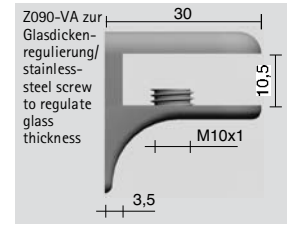
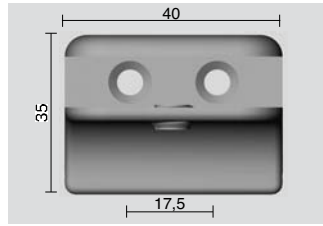

04

Artikel-Nr. article-no.	Oberflächen finishes	Artikelbezeichnung article name	Plattendicke plate thickness	Zubehör extras	VE/Stück pu/piece
2885	VA1, VA2	Glasplattenträger, 2 Befestigungsbohrungen Ø 4,5 mm für Senkkopfschrauben./glass plate support, 2 holes Ø 4,5 mm for fastening countersink head screws.	6 – 10 mm	-	1/20

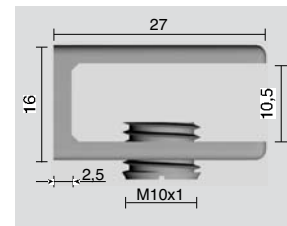
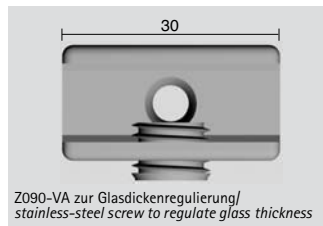

Artikel-Nr. article-no.	Oberflächen finishes	Artikelbezeichnung article name	Plattendicke plate thickness	Zubehör extras	VE/Stück pu/piece
2880	VA1, VA2	Glasplattenträger, 1 Befestigungsbohrung Ø 4,5 mm für Senkkopfschraube./glass plate support, 1 hole Ø 4,5 mm for fastening countersink head screw.	6 – 10 mm	-	1/20

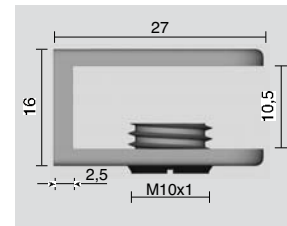
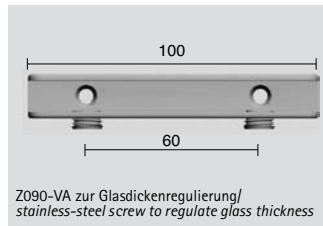

Artikel-Nr. article-no.	Oberflächen finishes	Artikelbezeichnung article name	Plattendicke plate thickness	Zubehör extras	VE/Stück pu/piece
2881	VA1, VA2	Glasplattenträger, 2 Befestigungsbohrungen Ø 4,5 mm für Senkkopfschrauben./glass plate support, 2 holes Ø 4,5 mm for fastening countersink head screws.	6 – 10 mm	-	1/20

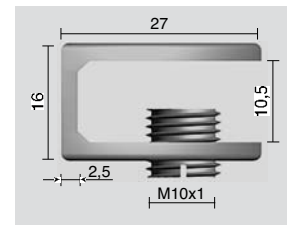
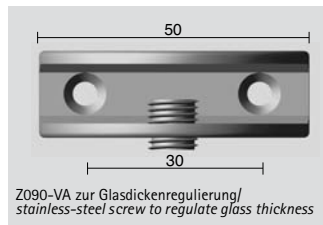

Artikel-Nr. article-no.	Oberflächen finishes	Artikelbezeichnung article name	Plattendicke plate thickness	Zubehör extras	VE/Stück pu/piece
2884	VA1, VA2	Glasplattenträger, 2 Befestigungsbohrungen Ø 4,5 mm für Senkkopfschrauben./glass plate support, 2 holes Ø 4,5 mm for fastening countersink head screws.	6 – 10 mm	-	1/20



Z090-VA zur Glasdickenregulierung / stainless-steel screw to regulate glass thickness

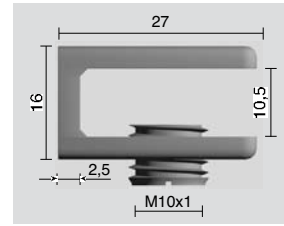
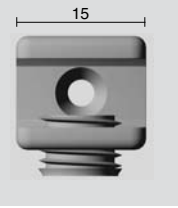

Artikel-Nr. article-no.	Oberflächen finishes	Artikelbezeichnung article name	Plattendicke plate thickness	Zubehör extras	VE/Stück pu/piece
2886	VA1, VA2	Glasplattenträger, 1 Befestigungsbohrung Ø 4,5 mm für Senkkopfschraube. / glass plate support, 1 hole Ø 4,5 mm for fastening countersunk head screw.	6 – 10 mm	-	1/20



Z090-VA zur Glasdickenregulierung / stainless-steel screw to regulate glass thickness

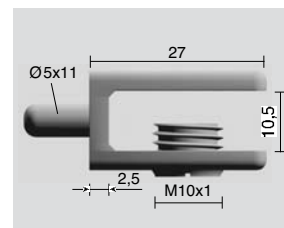
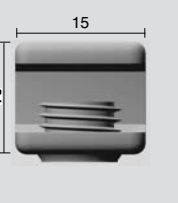

Artikel-Nr. article-no.	Oberflächen finishes	Artikelbezeichnung article name	Plattendicke plate thickness	Zubehör extras	VE/Stück pu/piece
2887	VA1, VA2	Glasplattenträger mit 1 Zapfen Ø 5x11 mm Länge für Lochwände / glass plate support with 1 pin Ø 5x11 mm length for predrilled walls	6 – 10 mm	-	1/20



Z090-VA zur Glasdickenregulierung / stainless-steel screw to regulate glass thickness

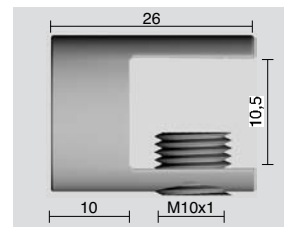
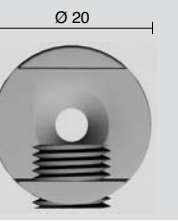

Artikel-Nr. article-no.	Oberflächen finishes	Artikelbezeichnung article name	Plattendicke plate thickness	Zubehör extras	VE/Stück pu/piece
2877	VA1, VA2	Glasplattenträger, 1 Befestigungsbohrung M6 mit Senkung für M5-Senkkopfschrauben. Auf Anfrage für Rundrohr lieferbar. / glass plate support, 1 fastening hole M6 with countersink for M5 countersink screw. On request available for round tubes.	6 – 10 mm	2878 ST8 2879	1/20

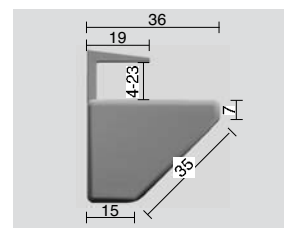
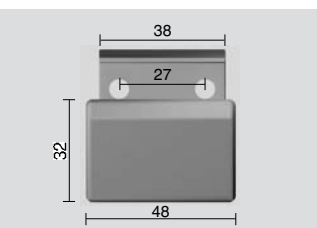
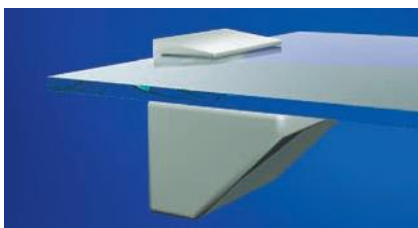

Artikel-Nr. article-no.	Oberflächen finishes	Artikelbezeichnung article name	Plattendicke plate thickness	Zubehör extras	VE/Stück pu/piece
4938	VA1, VA2	Regalbodenträger, stufenlos verstellbar. 2 Befestigungsbohrungen Ø 5,5 mm für Senkkopfschrauben. / shelf support, infinitely variable. 2 holes Ø 5,5 mm for fastening countersink head screws.	4 – 23 mm	-	1/10

04

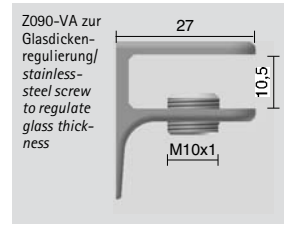
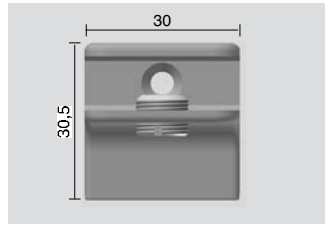

Artikel-Nr. article-no.	Oberflächen finishes	Artikelbezeichnung article name	Plattendicke plate thickness	Zubehör extras	VE/Stück pu/piece
3071	VA1, VA2	Glasplattenträger, 1 Befestigungsbohrung Ø 4,5 mm für Senkkopfschraube./glass plate support, 1 hole Ø 4,5 mm for fastening countersink head screw.	6 – 10 mm	-	1/20

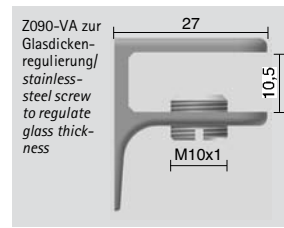
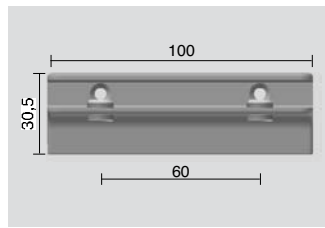

Artikel-Nr. article-no.	Oberflächen finishes	Artikelbezeichnung article name	Plattendicke plate thickness	Zubehör extras	VE/Stück pu/piece
3072	VA1, VA2	Glasplattenträger, 2 Befestigungsbohrungen Ø 4,5 mm für Senkkopfschrauben./glass plate support, 2 holes Ø 4,5 mm for fastening countersink head screws.	6 – 10 mm	-	1/20

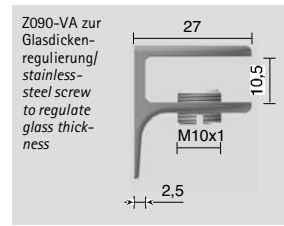
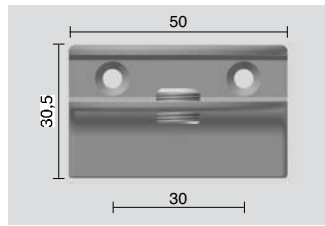

Artikel-Nr. article-no.	Oberflächen finishes	Artikelbezeichnung article name	Plattendicke plate thickness	Zubehör extras	VE/Stück pu/piece
3073	VA1, VA2	Glasplattenträger, 2 Befestigungsbohrungen Ø 4,5 mm für Senkkopfschrauben./glass plate support, 2 holes Ø 4,5 mm for fastening countersink head screws.	6 – 10 mm	-	1/20

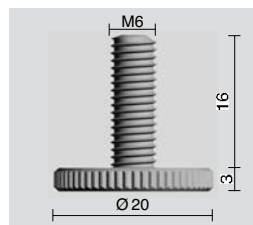

Artikel-Nr. article-no.	Oberflächen finishes	Artikelbezeichnung article name	VE/Stück pu/piece
2879	VA0 = (ZN1), VA1 = (ZN5) VA2 = (ZN22), VA7 = (ZN7) VA14 = (ZN14) RAL-Farben/RAL-colours	Rändelschraube M6x16 mit 2 KU-Unterlegscheiben und 1 KU-Schlauchstück ø8xø6x6,5 mm./ knurled thumb screw M6x16 with 2 plastic washers and 1 plastic tube ø8xø6x6,5 mm.	1/20

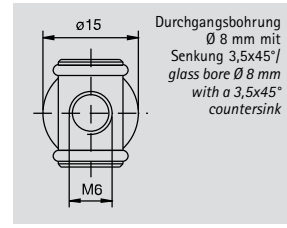
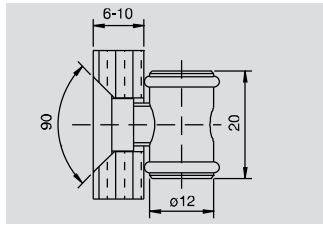

Artikel-Nr. article-no.	Oberflächen finishes	Artikelbezeichnung article name	Plattendicke plate thickness	Zubehör extras	VE/Stück pu/piece
3040	VA	Glasbodenträger „Bottini“/ glass shelf support "Bottini"	6 - 10 mm	-	1/20

04

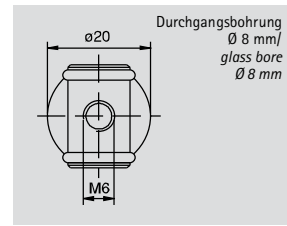
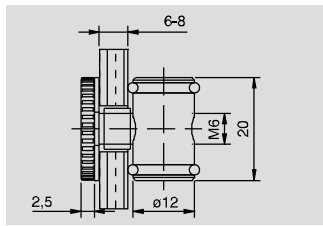

Artikel-Nr. article-no.	Oberflächen finishes	Artikelbezeichnung article name	Plattendicke plate thickness	Zubehör extras	VE/Stück pu/piece
3045	VA	Glasbodenträger „Bottini“/ glass shelf support "Bottini"	6 - 8 mm	-	1/20

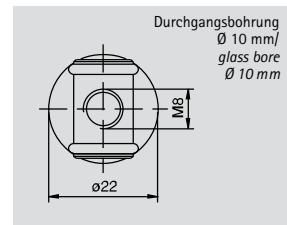
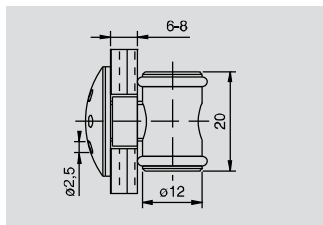

Artikel-Nr. article-no.	Oberflächen finishes	Artikelbezeichnung article name	Plattendicke plate thickness	Zubehör extras	VE/Stück pu/piece
3050	VA	Glasbodenträger „Bottini“ erhaben/ glass shelf support "Bottini" elevated	6 - 8 mm	Z059	1/20
Z059	-	Verstellbarer Stirnlochschlüssel/ adjustable face spanner	-	-	1/1

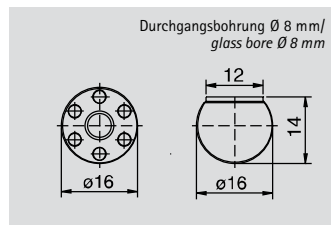
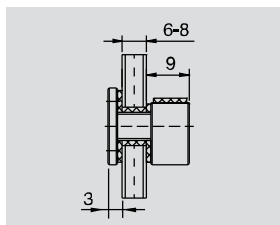

Artikel-Nr. article-no.	Oberflächen finishes	Artikelbezeichnung article name	Plattendicke plate thickness	Zubehör extras	VE/Stück pu/piece
3035	VA	Glasbodenträger „Nano“/ glass shelf support "Nano"	6-8 mm	Z059	1/20
Z059	-	Verstellbarer Stirnlochschlüssel/ adjustable face spanner	-	-	1/1

Glasplattenträger/Designerkollektion *glass plate supports/designer collection*



Glasplattenträger „Designerkollektion“/
glass plate supports "designer collection"
Glasplattenträger/
glass plate supports

Ralph-Rainer Matthis
Geboren 1958 in Freiburg, Diplom Designer, zur Zeit in Krefeld. Sein vorrangiges Arbeitsfeld ist die Gestaltung am Glas.

Ralph-Rainer Matthis
Born 1958 in Freiburg, he majored in design at the present time he is working in Krefeld. His major field of work is a combination of forming and presenting glass.

04

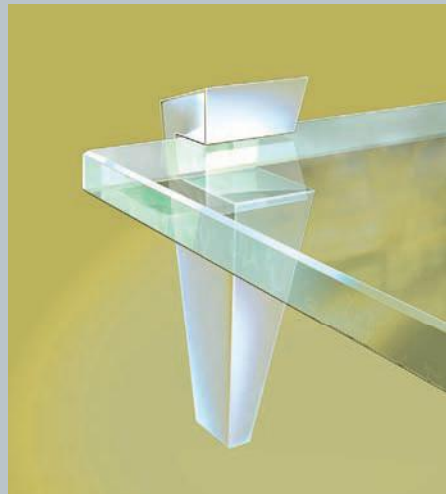
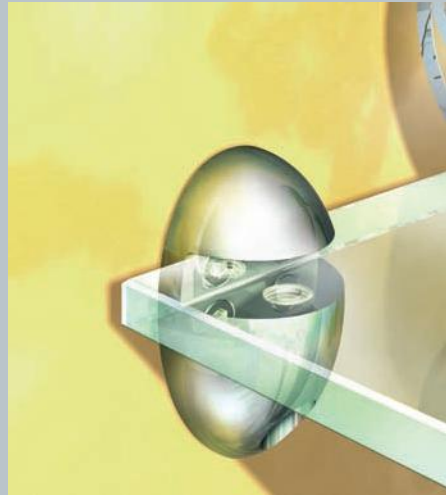

Unter www.steelmax.de finden Sie unter anderem
made by c. pauli
 die Designer-Glasplattenträger von Pauli + Sohn inkl. Glasplatte/
 on www.steelmax.de you will find among other things
 the designer glass supports of Pauli + Sohn incl. glass plate



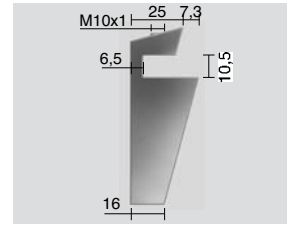
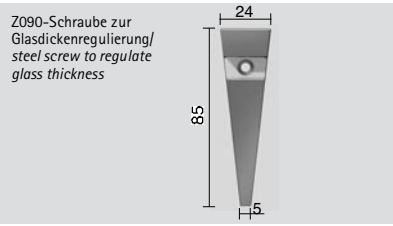
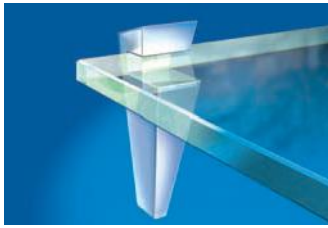

Artikel-Nr. article-no.	Oberflächen finishes	Artikelbezeichnung article name	Plattendicke glass thickness	Zubehör extras	VE/Stück pu/piece
10010	ZN1, ZN5, ZN22, RAL-Farben/RAL colours	Glasplattenträger KONO, 1 Befestigungsbohrung Ø 4,5 mm für Senkkopfschraube./glass plate support KONO, 1 hole Ø 4,5 mm for fastening countersink head screw.	6 – 10 mm	Z090-KU	1/20

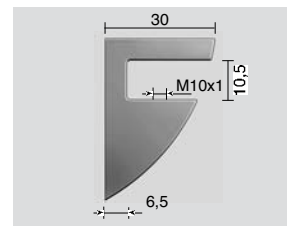
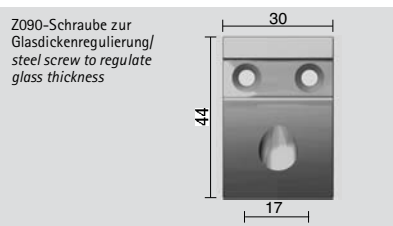
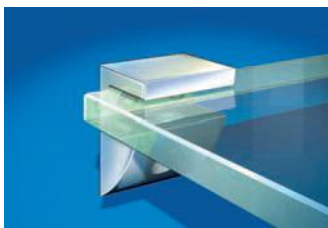

Artikel-Nr. article-no.	Oberflächen finishes	Artikelbezeichnung article name	Plattendicke glass thickness	Zubehör extras	VE/Stück pu/piece
10020	ZN1, ZN5, ZN22, RAL-Farben/RAL colours	Glasplattenträger STIPO, 2 Befestigungsbohrungen Ø 4,5 mm für Senkkopfschrauben./glass plate support STIPO, 2 holes Ø 4,5 mm for fastening countersink head screws.	6 – 10 mm	Z090-KU	1/20

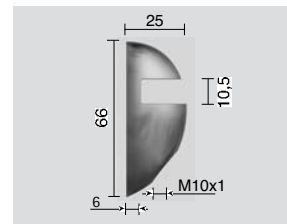
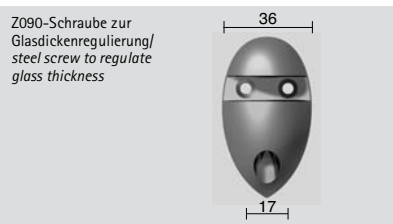

Artikel-Nr. article-no.	Oberflächen finishes	Artikelbezeichnung article name	Plattendicke glass thickness	Zubehör extras	VE/Stück pu/piece
10030	ZN1, ZN5, ZN22, RAL-Farben/RAL colours	Glasplattenträger OVO, 2 Befestigungsbohrungen Ø 4,5 mm für Senkkopfschrauben./glass plate support OVO, 2 holes Ø 4,5 mm for fastening countersink head screws.	6 – 10 mm	Z090-KU	1/20

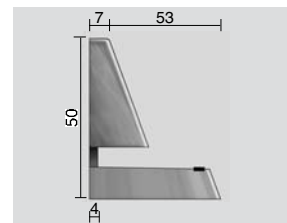
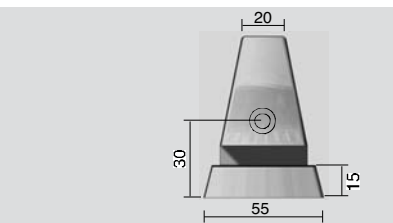
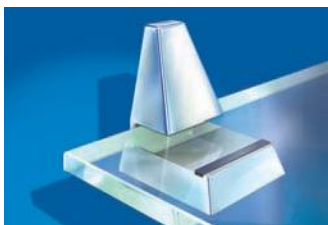

Artikel-Nr. article-no.	Oberflächen finishes	Artikelbezeichnung article name	Plattendicke glass thickness	Zubehör extras	VE/Stück pu/piece
10040	ZNO, ZN1, ZN5, ZN22, RAL-Farben/RAL colours	Glasplattenträger MONTI, 1 Befestigungsbohrung Ø 6,5 mm für Senkkopfschraube./glass plate support MONTI, 1 hole Ø 6,5 mm for fastening countersink head screw.	8 – 12 mm	-	1/6

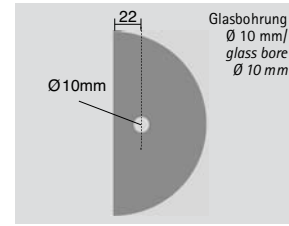
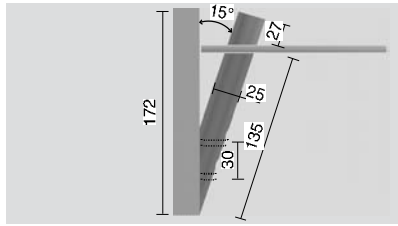

Artikel-Nr. article-no.	Oberflächen finishes	Artikelbezeichnung article name	Plattendicke glass thickness	Zubehör extras	VE/Stück pu/piece
10000	ZN1, ZN5, ZN22, RAL-Farben auf Anfrage/RAL colours on request	Glasplattenträger ARCHIA, 2 Befestigungsbohrungen Ø 6 mm, 2 KU-Unterlegscheiben, 1 Zylinderkopfschraube M5x35, 2 Zink-Kerne, 1 Zink-Abdeckkappe, 1 Zink-Abdeckhülse/ glass plate support ARCHIA, 2 fastening holes Ø 6 mm, 2 plastic washers, 1 cylinder head screw M5x35, 2 zinc cores, 1 zinc cap, 1 zinc sleeve	6 – 12 mm	-	1/2

Artikel-Nr. article-no.	Max. a max. a	Tragfähigkeit bei gleichmäßiger Lastverteilung bei einer Ausladung (e) von: load capacity on permanent load sharing on a overhang of (e) von:			Glasdicke glass thickness
		100	200	300	
2875	500 mm	37,5 kg	18,7 kg	12,5 kg	6 mm
2876	300 mm	7,5 kg	3,75 kg	2,5 kg	6 mm
2878	300 mm	4,5 kg	2,25 kg	1,5 kg	6 mm
2880	300 mm	7,5 kg	3,75 kg	2,5 kg	6 mm
2881	500 mm	30 kg	15 kg	10 kg	6 mm
2884	300 mm	7,5 kg	3,75 kg	2,5 kg	6 mm
2885	500 mm	37,5 kg	18,7 kg	12,5 kg	6 mm
2886	300 mm	4,5 kg	2,25 kg	1,5 kg	6 mm
2896	500 mm	42 kg	21 kg	14 kg	6 mm
3071	300 mm	18 kg	9 kg	6 kg	6 mm
3072	500 mm	37,5 kg	18,7 kg	12,5 kg	6 mm
3073	300 mm	18 kg	9 kg	6 kg	6 mm
4938	500 mm	30 kg	15 kg	10 kg	6 mm
4945*	500 mm	80 kg	60 kg	40 kg	10 mm
10000	300 mm	7,5 kg	3,75 kg	2,5 kg	6 mm
10010	300 mm	7,5 kg	3,75 kg	2,5 kg	6 mm
10020	500 mm	37,5 kg	18,7 kg	12,5 kg	6 mm
10030	300 mm	10,4 kg	5,2 kg	3,5 kg	6 mm
10040	300 mm	10,4 kg	5,2 kg	3,5 kg	6 mm
		150	200	250	
10050	300 mm	11 kg	8 kg	4 kg	6 mm

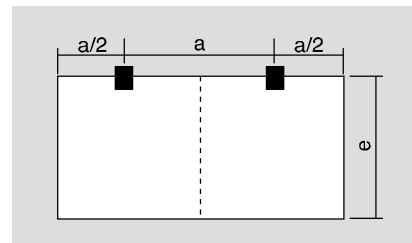

Die Maximallast kann als empfohlener Wert verstanden werden. Die Bruchlast liegt erheblich über dem empfohlenen Wert. Eine Erweiterung der Reagle ist problemlos möglich, bitte beachten Sie die maximale Abmessung max. a./
The maximum load can be understood as recommended value. The failure load is much more higher than the recommended value. To widen the bookshelf is possible without problems, the maximum measurement max a is to observe

* Belastungsangaben für 500 mm bei 3 Befestigungspunkten/
load capacity for 500 mm in combination with 3 fixation points

Träger support	Max. Zink max zinc	Max. VA max VA
2867	6 kg	-
2868	6 kg	-
2868	2,5 kg	5 kg
2887	2,5 kg	5 kg
2877	2,5 kg	5 kg
2883	2,5 kg	-
2873	2,5 kg	-
3070	-	5 kg
3080	-	5 kg

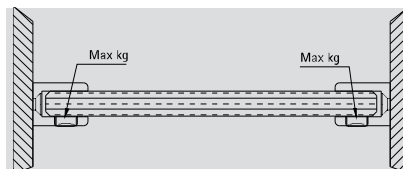

Ergebnisse beziehen sich auf die Auflagefläche von einem Glasplattenträger 4 sind zu verwenden/Test results in application of area of support of one support.

